



# BONFIGLIOLI RIDUTTORI

## Worm Gear Series

Supplement



**VF**



**W**



**VF/VF - VF/W  
W/VF**



**BONFIGLIOLI**

*Power & Control Solutions*

# Worm Gear Series

## Product Features

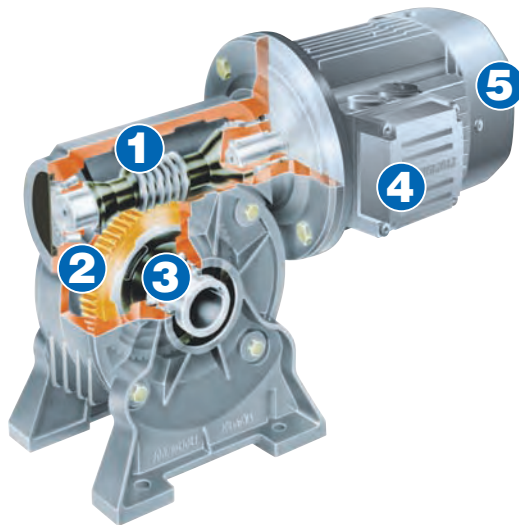

- 1) - Wormshaft from case hardened alloy steel with ground finished tooth flank.
- 2) - Shell-casted phosphor bronze gearwheels.
- 3) - Output shaft bearings are suitably rated for substantial shaft loading.
- 4) - Motor larger conduit box
- 5) - Motor improved ventilation

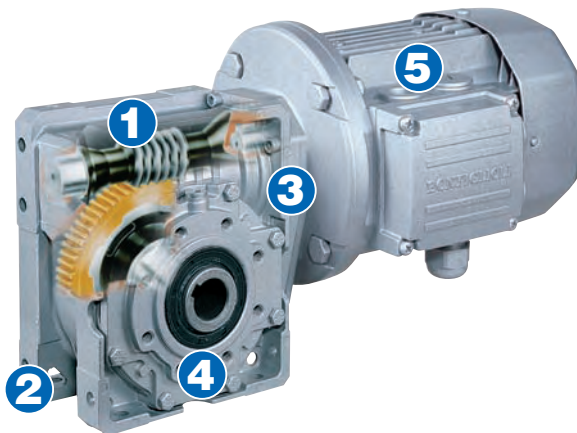

- 1) - Wormshaft from hardened steel, ground finished on tooth profile.
- 2) - Through holes facilitate discharge of water after wash-down
- 3) - Monolithic Aluminium gearcase..
- 4) - Vented side cover adjusts to any mounting position (patent pending).
- 5) - Numerous motor options. Compact style also available.

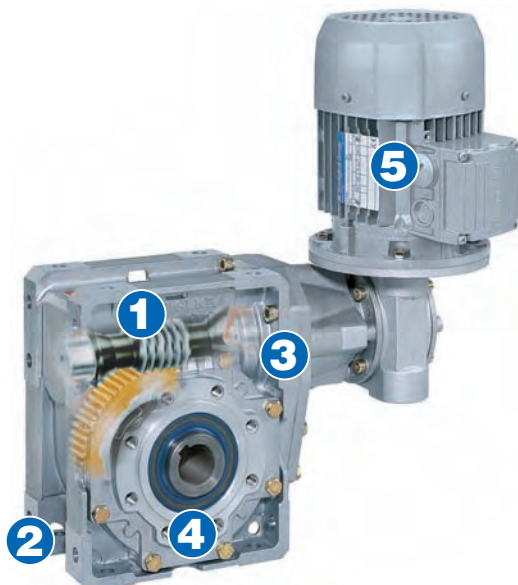

- 1) - Wormshaft from hardened steel, ground finished on tooth profile.
- 2) - Through holes facilitate discharge of water after wash-down
- 3) - Monolithic Aluminium gearcase.
- 4) - Vented side cover adjusts to any mounting position (patent pending).
- 5) - Numerous motor options. Compact style also available.

This catalog is a supplement to the standard red Bonfiglioli metric catalogs. It provides for easy speed reducer/gearmotor selection using North American units (such as horsepower and lb•in.). When evaluating an application, it is recommended that final selections be reviewed by Bonfiglioli personnel. As this is a supplement, refer to the metric catalogs (**1847 R4**) for more detail in regards to each gearbox and gearmotor.

## INDEX

### 1.0 GENERAL INFORMATION

Par.	Description	Page
1.1	SYMBOLS AND U.M. ....	2
1.2	OUTPUT TORQUE .....	3
1.3	POWER .....	3
1.4	THERMAL CAPACITY .....	3
1.5	EFFICIENCY .....	3
1.6	MASS MOMENT OF INERTIA .....	4
1.7	SERVICE FACTOR .....	4
1.8	SELECTION .....	4
1.9	VERIFICATION .....	8
1.10	INSTALLATION .....	8
1.11	STORAGE .....	9
1.12	MAINTENANCE .....	9

### 2.0 WORM GEAR SERIES

Par.	Description	Page
	ORDERING NUMBERS .....	10
	GEARMOTOR SELECTION CHARTS .	14
	SPEED REDUCER RATING CHARTS .	33

### 3.0 ELECTRIC MOTORS

Par.	Description	Page
3.1	GENERAL INFORMATION .....	47
3.2	MOTOR DESIGNATION .....	48
3.3	MECHANICAL CHARACTERISTICS ...	49
3.4	ELECTRIC CHARACTERISTICS .....	51
3.5	BRAKE MOTORS .....	54
3.6	DC BRAKE MOTORS TYPE BN_FD ...	55
3.7	AC BRAKE MOTORS TYPE BN_FA ...	59
3.8	BRAKE RELEASE SYSTEMS .....	61
3.9	OPTIONS .....	62
3.10	COMPACT MOTOR RATING CHARTS ...	66
3.11	IEC MOTOR RATING CHARTS .....	69
3.12	DIMENSIONS .....	73

### CROSS REFERENCE PAGE NUMBERS

Par.	Description	W - VF 1847 R4 Page
	DESIGN CHARACTERISTICS .....	16
	GEARBOX DESIGNATION .....	22
	LUBRICATION .....	36
	RADIAL LOADS .....	38
	THRUST LOAD .....	40
	IEC MOTOR AVAILABILITY .....	108
	MOMENT OF INERTIA .....	111
	DIMENSIONS .....	120
	TORQUE ARM .....	186
	TORQUE LIMITER .....	187

#### Revisions

Refer to page 78 for the catalogue revision index.

Visit [www.bonfiglioli.com](http://www.bonfiglioli.com) to search for catalogues with latest revision index.

# 1.0 GENERAL INFORMATION

## 1.1 SYMBOLS AND UNITS

Symb.	U.m.	Description	Symb.	U.m.	Description
<b>A<sub>c</sub></b>	[lbs]	Calculated thrust load	<b>P<sub>n</sub></b>	[hp]	Rated horsepower
<b>A<sub>n</sub></b>	[lbs]	Rated thrust load	<b>P<sub>t</sub></b>	[hp]	Thermal capacity
<b>f<sub>m</sub></b>	–	Adjusting power factor	<b>P<sub>r</sub></b>	[hp]	Power required
<b>S.F.</b>	–	Service factor	<b>R<sub>c</sub></b>	[lbs]	Calculated radial load
<b>f<sub>t</sub></b>	–	Thermal correction factor	<b>R<sub>n</sub></b>	[lbs]	Rated OHL
<b>i</b>	–	Transmission ratio	<b>R<sub>x</sub></b>	[lbs]	Radial OHL for load shifted from shaft midpoint
<b>I</b>	–	Intermittence	<b>S</b>	–	Safety factor
<b>J<sub>c</sub></b>	[lb·ft <sup>2</sup> ]	Load moment of inertia	<b>t<sub>a</sub></b>	[°C/ °F]	Ambient temperature
<b>J<sub>m</sub></b>	[lb·ft <sup>2</sup> ]	Mass moment of inertia for motor	<b>t<sub>f</sub></b>	[min]	Operating time under constant load
<b>J<sub>r</sub></b>	[lb·ft <sup>2</sup> ]	Mass moment of inertia for gearbox	<b>t<sub>r</sub></b>	[min]	Rest time
<b>K</b>	–	Acceleration factor of masses	<b>W</b>	[ft·lb]	Brake dissipated energy between two successive air-gap adjustments
<b>K<sub>r</sub></b>	–	Radial load stress factor	<b>W<sub>max</sub></b>	[ft·lb]	Maximum energy for each braking operation
<b>T<sub>b</sub></b>	[lb·in]	Brake torque	<b>x</b>	[in]	Load application distance from shaft shoulder
<b>T</b>	[lb·in]	Torque	<b>Z</b>	[1/h]	Number of permitted motor starts in loaded conditions
<b>T<sub>c</sub></b>	[lb·in]	Calculated torque	<b>Z<sub>r</sub></b>	[1/h]	Number of starts
<b>T<sub>n</sub></b>	[lb·in]	Speed reducer rated torque	<b>η<sub>d</sub></b>		Dynamic efficiency
<b>T<sub>r</sub></b>	[lb·in]	Torque required			
<b>n</b>	[rpm]	Speed			
<b>P</b>	[hp]	Power			
<b>P<sub>c</sub></b>	[hp]	Calculated power			
<b>P<sub>n</sub></b>	[hp]	Motor rated power			

---

Footnotes:

□<sub>1</sub> *Applies to input shaft*

□<sub>2</sub> *Applies to output shaft*

## NOMENCLATURE

### 1.2 OUTPUT TORQUE

#### Nominal output torque

 $T_{n2}$ 

Torque transmitted at output shaft under uniform load, referred to input speed  $n_1$  and corresponding output speed  $n_2$ .

It is calculated according to service factor S.F. = 1.

#### Application torque

 $T_{r2}$ 

This is torque corresponding to application requirements. It must be equal to or less than rated output torque  $T_{n2}$  for the gearmotor selected.

#### Calculated torque

 $T_{c2}$ 

Torque value to be used for selecting the gearbox, considering required torque  $T_{r2}$  and service factor S.F., and is obtained by:

$$T_{c2} = T_{r2} \times \text{S.F.} \leq T_{n2}$$

### 1.3 POWER

#### Rated input horsepower

 $P_{n1}$ 

In the speed reducer selection charts, this is power applicable at input shaft, referred to speed  $n_1$ , and considering a service factor S.F. = 1.

#### Output horsepower

 $P_{n2}$ 

Value represents rated HP as referred to speed reducer output shaft.

$$P_{n2} = P_{n1} \times \eta_d$$

$$P_{n2} = \frac{T_{n2} \times n_2}{63025}$$

$P_{n2}$  in [hp];  $M_{n2}$  in [lb-in]

### 1.4 THERMAL CAPACITY $P_t$

The value indicates the speed reducer thermal limit and corresponds to the power transmission capacity under continuous duty at an ambient temperature of 20°C[70°F] without using a supplementary cooling system.

For short operating periods with sufficiently long pauses to allow the unit to cool, thermal capacity does not need to be taken into consideration.

For ambient temperature different from 20°C[70°F] and intermittent duty,  $P_t$  value can be adjusted by means of thermal factor  $f_t$  shown in table (A1), provided the following condition is satisfied.

$$P_{r1} \leq P_t \times f_t$$

(A1)

ta max. °C [°F]	Continuous duty	$f_t$			
		Intermittent duty			
		Intermittence % (I)			
		80	60	40	20
40 [105]	0.8	1.1	1.3	1.5	1.6
30 [85]	0.85	1.3	1.5	1.6	1.8
20 [70]	1	1.5	1.6	1.8	2.0
50 [10]	1.15	1.6	1.8	2.0	2.3

Intermittence (I)% is obtained dividing operating time under load [ $t_f$ ] by total time, expressed as a percentage:

$$I = \frac{t_f}{t_f + t_r} \times 100$$

### 1.5 EFFICIENCY $\eta$

 $\eta$ 

Obtained from the relationship of output power  $P_2$ , to input power  $P_1$ , according to the following equation:

$$\eta = \frac{P_2}{P_1}$$

Torque value  $M_{n2}$  specified in this catalogue accounts for dynamic efficiency  $\eta_d$ .

## 1.6 MASS MOMENT OF INERTIA $J_r$

Values for the moment of inertia specified in the catalogue refer to gear unit input shaft.

They are therefore related to motor speed, in the case of direct motor mounting.

## 1.7 SERVICE FACTOR $S.F.$

This factor is the numeric value describing reducer service duty. It takes into consideration, with unavoidable approximation, daily operating conditions, load variations and overloads connected with reducer application. In the graph (A2) below, after selecting proper "daily working hours" column, the service factor is given by intersecting the number of starts per hour and one of the K1, K2 or K3 curves.

K\_ curves are linked with the service nature (approximately: uniform, medium and heavy) through the acceleration factor of masses K, connected to the ratio between driven masses and motor inertia values.

Regardless of the value given for the service factor, we would like to remind that in some applications, which for example involve lifting of parts, failure of the reducer may expose the operators to the risk of injuries.

If in doubt, please contact our Technical Service Department.

(A2)

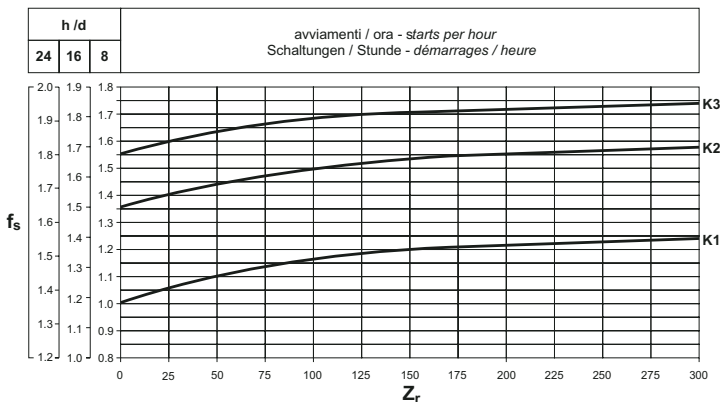

## Acceleration factor of masses $K$

Used for establishing the service factor and obtained from the following equation:

$$K = \frac{J_c}{J_m}$$

Where:

$J_c$  [lb·ft<sup>2</sup>]

dynamic moment of inertia of the driven masses in proportion to the speed of the applied motor

$J_m$  [lb·ft<sup>2</sup>]

motor moment of inertia

**K1** uniform load

$K \leq 0.25$

**K2** moderate shock load

$K \leq 3$

**K3** heavy shock load

$K \leq 10$

For  $K > 10$  values, please contact our Technical Service.

## 1.8 SELECTION

### AGMA Service Factor charting

(A3)

Application	S.F.
<b>AGITATORS</b>	
Pure Liquids	1.25
Liquids & Solids	1.50
Liquids - variable density	1.50
<b>BLOWERS</b>	
Centrifugal	1.25
Lobe	1.50
Vane	1.50
<b>BREWING AND DISTILLING</b>	
Bottling Machinery	1.25
Brew Kettles - Continuous Duty	1.25
Cookers - Continuous Duty	1.25
Mash Tubs - Continuous Duty	1.25
Scale Hopper - Frequent Starts	1.50
<b>CAN FILLING MACHINES</b>	1.25
<b>CAR DUMPERS</b>	2.00
<b>CAR PULLERS</b>	1.50
<b>CLARIFIERS</b>	1.25
<b>CLASSIFIERS</b>	1.50
<b>CLAY WORKING MACHINERY</b>	
Brick Press	2.00
Briquette Machine	2.00
Pug Mill	1.50
<b>COMPACTORS</b>	2.00
<b>COMPRESSORS</b>	
Centrifugal	1.25
Lobe	1.50

Application	S.F.
Reciprocating, Multi-Cylinder	1.75
Reciprocating, Single-Cylinder	2.00
<b>CONVEYORS - GENERAL PURPOSE</b>	
<i>includes Apron, Assembly, Belt, Bucket, Chain, Flight, Oven and Screw</i>	
Uniformly Loaded or Fed	1.25
Heavy Duty - Not Uniformly Fed	1.50
Severe Duty - Reciprocating or Shaker	2.00
<b>CRANES</b>	
<b>Dry Dock</b>	
Main Hoist	2.50
Auxiliary Hoist	3.00
Boom Hoist	3.00
Slewing Hoist	3.00
Traction Drive	3.00
<b>Container</b>	
Main Hoist	3.00
Boom Hoist	2.00
Trolley Drive	
Gantry Drive	3.00
Traction Drive	2.00
<b>Mill Duty</b>	
Main Hoist	3.50
Auxiliary	3.50
Bridge Travel	3.00
Trolley Travel	3.00
<b>Industrial Duty</b>	
Main	3.00
Auxiliary	3.00
Bridge Travel	3.00
Trolley Travel	3.00
<b>CRUSHERS</b>	
Stone or Ore	2.00
<b>DREDGES</b>	
Cable Reels	1.50
Conveyors	1.50
Cutter Head Drives	2.00
Pumps	2.00
Screen Drives	2.00
Stackers	1.50
Winches	1.50
<b>ELEVATORS</b>	
Bucket	1.50
Centrifugal Discharge	1.25
Escalators	1.25
Freight	1.50
Gravity Discharge	1.25
<b>EXTRUDERS</b>	
General	1.50
<b>Plastics</b>	
Variable Speed Drive	1.50
Fixed Speed Drive	1.75

Application	S.F.
<b>Rubber</b>	
Continuous Screw Operation	1.75
Intermittent Screw Operation	1.75
<b>FANS</b>	
Centrifugal	1.25
Cooling Towers	2.00
Forced Draft	1.25
Induced Draft	1.50
Industrial & Mine	1.50
<b>FEEDERS</b>	
Apron	1.50
Belt	1.50
Disc	1.25
Reciprocating	2.00
Screw	1.50
<b>FOOD INDUSTRY</b>	
Cereal Cooker	1.25
Dough Mixer	1.50
Meat Grinder	1.50
Slicers	1.50
<b>GENERATORS AND EXITORS</b>	1.25
<b>HAMMER MILLS</b>	2.00
<b>HOISTS</b>	
Heavy Duty	2.00
Medium Duty	1.50
Skip Hoist	1.50
<b>LUMBER INDUSTRY</b>	
<b>Barkers</b>	
Spindle Feed	1.50
Main Drive	1.75
<b>Conveyors</b>	
Burner	1.50
Main or Heavy Duty	1.50
Main Log	2.00
Re-saw, Merry-Go-Round	1.50
Slab	2.00
Transfer	1.50
<b>Chains</b>	
Floor	1.50
Green	1.75
<b>Cut-Off Saws</b>	
Chain	1.75
Drag	1.75
Debarking Drums	2.00
<b>Feeds</b>	
Edger	1.50
Gang	1.75
Trimmer	1.50
Log Deck	1.75
Log Hauls - Incline - Well Type	1.75
Log Turning Devices	1.75
Planer Feed	1.50

Application	S.F.
Planer Tilting Hoists	1.50
Rolls - Live-off brg. - Roll Cases	1.75
Sorting Table	1.50
Tipple Hoist	1.50
<b>Transfer</b>	
Chain	1.75
Craneway	1.75
Tray Drives	1.50
Veneer Lathe Drives	1.50
<b>METAL MILLS</b>	
Draw Bench Carriage and Main Drive	1.50
Runout Table	
Non-reversing	1.50
Group Drives	1.50
Individual Drives	2.00
Reversing	2.00
Slab Pushers	1.50
Shears	2.00
Wire Drawing	1.50
Wire Winding Machine	1.50
<b>METAL STRIP PROCESSING MACHINERY</b>	
Bridles	1.50
Coilers & Uncoilers	1.25
Edge Trimmers	1.50
Flatteners	1.50
Loopers (Accumulators)	1.25
Pinch Rolls	1.50
Scrap Choppers	1.50
Shears	2.00
Slitters	1.50
<b>MILLS, ROTARY TYPE</b>	
<b>Ball &amp; Rod</b>	
Spur Ring Gear	2.00
Helical Ring Gear	1.50
Direct Connected	2.00
Cement Kilns	1.50
Dryers & Coolers	1.50
<b>MIXERS, CEMENT</b>	1.50
<b>PAPER MILLS</b>	
Agitator (Mixer)	1.50
Agitator for Pure Liquors	1.25
Barking Drums	2.00
Barkers - Mechanical	2.00
Beater	1.50
Breaker Stack	1.25
Calendar	1.25
Chipper	2.00
Chip Feeder	1.50
Coating Rolls	1.25
<b>Conveyors</b>	
Chip, Bark, Chemical	1.25
Log (including Slab)	2.00

Application	S.F.
Couch Rolls	1.25
Cutter	2.00
Cylinder Molds	1.25
<b>Dryers</b>	
Paper Machine	1.25
Conveyor Type	1.25
Embosser	1.25
Extruder	1.50
Fourdrinier Rolls	1.25
(includes Lump breaker, dandy roll, wire turning, and return rolls)	
Jordan	1.50
Kiln Drive	1.50
Mt. Hope Roll	1.25
Paper Rolls	1.25
Platter	1.50
Presses - Felt & Suction	1.25
Pulper	2.00
Pumps - Vacuum	1.50
Reel (Surface Type)	1.25
<b>Screens</b>	
Chip	1.50
Rotary	1.50
Vibrating	2.00
Size Press	1.25
Super Calender	1.25
Thickener (AC Motor)	1.50
Thickener (DC Motor)	1.25
Washer (AC Motor)	1.50
Washer (DC Motor)	1.25
Wind and Unwind Stand	1.25
Winders (Surface Type)	1.25
Yankee Dryers	1.25
<b>PLASTICS INDUSTRY - PRIMARY PROCESSING</b>	
<b>Intensive Internal Mixers</b>	
Batch Mixers	1.75
Continuous Mixers	1.50
Batch Drop Mill - 2 smooth rolls	1.25
Continuous Feed, Holding & Blend Mill	1.25
Calender	1.50
<b>PLASTICS INDUSTRY - SECONDARY PROCESSING</b>	
Blow Molder	1.50
Coating	1.25
Film	1.25
Pipe	1.25
Pre-Plasticizer	1.50
Rods	1.25
Sheet	1.25
Tubing	1.50
<b>PULLER - BARGE HAUL</b>	1.50
<b>PUMPS</b>	
Centrifugal	1.25
Proportioning	1.50



Application	S.F.
<b>Reciprocating</b>	
Single Acting, 3 or more cylinders	1.50
Double Acting, 2 or more cylinders	1.50
<b>Rotary</b>	
Gear Type	1.25
Lobe	1.25
Vane	1.25
<b>RUBBER INDUSTRY</b>	
<b>Intensive Internal Mixers</b>	
Batch Mixers	1.75
Continuous Mixers	1.50
<b>Mixing Mill</b>	
2 smooth rolls	1.50
1 or 2 corrugated rolls	
Batch Drop Mill - 2 smooth rolls	1.50
Cracker - 2 corrugated rolls	2.00
Holding, Feed & Blend Mill - 2 rolls	1.25
Refiner - 2 rolls	1.50
Calender	1.50
<b>SAND MULLER SEWAGE DISPOSAL EQUIPMENT</b>	1.50
Bar Screens	1.25
Chemical Feeders	1.25
Dewatering Screens	1.50
Scum Breakers	1.50
Slow or Rapid Mixers	1.50
Sludge Collectors	1.25
Thickener	1.50
Vacuum Filters	1.50
<b>SCREENS</b>	
Air Washing	1.25
Rotary - Stone or Gravel	1.50
Traveling Water Intake	1.25
<b>SUGAR INDUSTRY</b>	
Beet Slicer	2.00
Cane Knives	1.50
Crushers	1.50
Mills (low speed end)	1.75
<b>TEXTILE INDUSTRY</b>	
Batchers,	1.50
Calenders	1.50
Cards	1.50
Dry Cans	1.50
Dyeing Machinery	1.50
Looms	1.50
Mangles	1.50
Nappers	1.50
Pads	1.50
Slashers	1.50
Soapers	1.50
Spinners	1.50
Tenter Frames	1.50
Washers	1.50
Winders	1.50

Recommended procedure for correct selection of the drive unit:

## Selecting a gearmotor

A) Determine service factor S.F. according to type of duty (factor K), number of starts per hour  $Z_r$  and duration of service.

B) Providing torque  $Tr_2$ , speed  $n_2$  and efficiency  $\eta_d$  are known, input power can be calculated as follows:

$$P_{r1}(\text{hp}) = \frac{Tr_2(\text{lb} \cdot \text{in}) \times n_2(\text{rpm})}{63,025 \times \eta_d}$$

Values of  $\eta_d$  for the different sizes of speed reducer are given in the rating charts at pages 35 through 47.

C) Consult the gearmotor selection charts and locate the table corresponding to power

$$P_n \geq P_{r1}$$

Unless otherwise specified, power  $P_n$  of motors indicated in the catalogue refers to continuous duty S1.

For motors used in conditions other than S1, the type of duty required by reference to CEI 2-3/IEC 600 34-1 Standards must be mentioned.

For duties from S2 to S8 in particular, and for IEC motor frame 132 or smaller, extra power can be obtained with respect to continuous duty, and the following condition should be verified:

$$P_n \geq \frac{P_{r1}}{f_m}$$

The adjusting factor  $f_m$  can be obtained from chart (A4).

(A4)

	DUTY						Please consult factory	
	S2			S3*				S4 - S8
	Cycle duration [min]			Intermittence (I)				
	10	30	60	25%	40%	60%		
$f_m$	1.35	1.15	1.05	1.25	1.15	1.1		

\* Cycle duration, in any event, must be 10 minutes or less. If it is longer, please contact our Technical Service Department.

$$\text{Intermittence: } I = \frac{t_f}{t_f + t_r} \times 100$$

$t_f$  = operating time at constant load  
 $t_r$  = rest time

Next, according to output speed  $n_2$ , select a gearmotor having a calculated safety factor  $S$  higher than or equal to service factor  $S.F.$

The gearmotor selection charts features combinations with 2, 4 and 6 pole motors.

If motors with different speed shall be used, refer to the selection procedure for speed reducers and choose the most suitable gear unit.

For applications such as hoisting and travelling, contact our Technical Service.

## Selecting a speed reducer with a motor adapter

A) Determine service factor  $S.F.$

B) Assuming the required output torque for the application  $T_{r2}$  is known, the calculated torque can be defined as:

$$T_{c2} = T_{r2} \times S.F.$$

C) The gear ratio is calculated according to requested output speed  $n_2$  and available input speed  $n_1$

$$i = \frac{n_1}{n_2}$$

Having calculated  $T_{c2}$  and (i), consult speed reducer selection charts referring to speed  $n_1$  and find the speed reducer which, as a function of the ratio (i) closest to the calculated value, provides rated torque of

$$T_{n2} \geq T_{c2}$$

If the selected speed reducer has to be fitted to an electric motor with either an IEC or a NEMA flange, check feasibility by consulting the tables listing the available motor adapters.

## 1.9 VERIFICATIONS

After selecting the drive unit, the following checks must be conducted:

A) Maximum torque

The maximum torque (intended as momentary peak load) applicable to the speed reducer must not, in general, exceed 300% of rated torque  $T_{n2}$ . Therefore,

check that this limit is not exceeded, using suitable torque limiting devices, if necessary.

For three-phase two speed motors, it is important to pay attention to switching torque generated (from high to low speed), because it could be significantly higher than maximum torque.

B) Radial loads

Check that radial forces applying on input and/or output shafts are within permitted catalogue values. If they are higher, select a larger speed reducer or change bearing arrangement.

Remember that all values listed in the catalogue refer to loads acting at mid-point of the shaft. The permissible radial load value should be adjusted if the radial load is not acting at mid point of shaft.

C) Thrust loads

Thrust loads, if applicable, must also be compared to the permitted values indicated in the catalogue.

In the event of extremely high thrust loads, or a combination of thrust and radial loads, contact our Technical Service Department.

D) Electric motors

For duties with considerable number of starts per hour, factor  $Z$  must be considered (it can be sorted from the motor rating chart). Factor  $Z$  defines the maximum number of starts for the application under consideration.

## 1.10 INSTALLATION

The following installation instructions must be followed:

A) Make sure that the speed reducer is adequately secured to avoid vibrations. If shocks, prolonged overloading, or the possibility of locking are expected, install hydraulic couplings, clutches, torque limiters, etc.).

B) Prior to paint coating, the outer face of the oil seals must be protected to prevent the solvent drying out the rubber, thus jeopardizing the oil-seal function.

C) Parts assembled on the speed reducer output shaft must be machined to ISO H7 tolerance to prevent interference fits that could damage the speed reducer itself. Further, to mount or remove such parts, use suitable pullers or extraction devices using the tapped hole located at the end of the shaft extension (solid shafts).

D) Contact surfaces must be cleaned and treated with

---

suitable protective products before mounting to avoid oxidation and, as a result, seizure of parts.

- E) Coupling to the speed reducer output hollow shaft (tolerance G7) is usually effected with shafts machined to h6 tolerance. If the type of application requires it, coupling with a slight interference (G7-j6) is possible.
- F) Before starting up the machine, make sure that oil level is correct for the actual mounting position, and that viscosity is suitable for the specific duty.

## 1.11 STORAGE

Observe the following instructions to ensure correct storage of products:

- A) Do not store outdoors, in areas exposed to weather or with excessive humidity.
- B) Always place wooden pallets or other material between floor and products, to avoid direct contact with the floor.
- C) For long term storage (over 60 days), all machined surfaces such as flanges, shafts and couplings must be protected with a suitable rust inhibiting product (Mobilarma 248 or equivalent).
- D) The following measures must be taken when products are stored for a period exceeding 6 months:
  - For life lubricated products, the machined areas must be greased to prevent oxidation.
  - In addition to above, products originally supplied w/o oil must be positioned with the breather plug at the highest point, and filled with oil.  
Before operating the speed reducer, restore the correct quantity of oil.

## 1.12 MAINTENANCE

Life lubricated speed reducers do not require periodical oil change.

For larger speed reducers, the first oil change must take place after about 300 hours of operation, flushing the interior of the unit using suitable detergents.

Do not mix mineral oils with synthetic oils.

Check oil periodically, and restore the level, if necessary.

## 2.0 WORM GEAR SERIES VF, W, VF/W

### ORDERING NUMBERS

#### Speed reducer designation - Series VF

**VF 49 L1 F1 — 28 P63 B5 B3 .....**

OPTIONS

MOUNTING POSITION

**B3** (Standard), **B6, B7, B8, V5, V6**

MOTOR MOUNTING

**B5** (IEC Standard VF30 - VF250, VFR49 - VFR250)

**B14** (on request VF30 - VF250)

INPUT STYLE

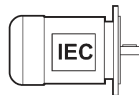

<b>P27*</b>	<b>S44**</b>
<b>P56</b>	<b>P112</b>
<b>P63</b>	<b>P132</b>
<b>P71</b>	<b>P160</b>
<b>P80</b>	<b>P180</b>
<b>P90</b>	<b>P200</b>
<b>P100</b>	<b>P225</b>

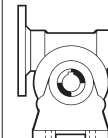

\*P27 = VF 27 only for combination with motor BN27.

\*\*S44 = VFR 44 gearbox supplied with dedicated compact motor BN44 only.

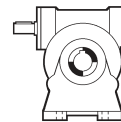

GEAR RATIO

OUTPUT SHAFT BORE

VERSION

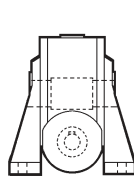

**N**  
(VF27...250)

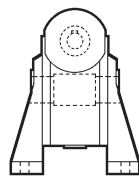

**A**  
(VF27...250)

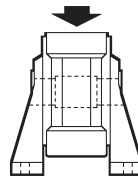

**V**  
(VF27...250)

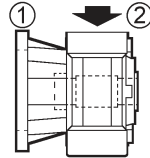

**F (1,2)**  
(VF27...185)

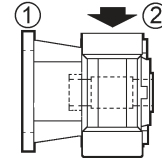

**FA (1,2)**  
(VF44-49)

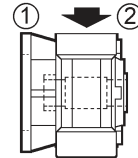

**FC (1,2)**  
(VF63...185)

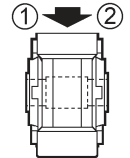

**P (1)**  
(VF30...86-210-250)

①-② Flange mounting side

TORQUE LIMITER

**L1, L2, LF**

FRAME SIZE

27, 30, 44, 49, 63, 72, 86, 110, 130, 150, 185, 210, 250 (VF)

44, 49, 63, 72, 86, 110, 130, 150, 185, 210, 250 (VFR)

30/44, 30/49, 30/63, 44/72, 44/86, 49/110, 63/130, 86/150, 86/185, 130/210, 130/250 (W/VF)

SERIES

**VF** = double worm gear

**VFR** = helical-worm gear unit

**VF/VF** = combined gearbox

## Speed reducer designation - Series W

**W 63 L1 UF1 — 24 S2 — B3 .....**

OPTIONS

MOUNTING POSITION

**B3** (Standard), **B6, B7, B8, V5, V6**

MOTOR MOUNTING

**B5** (W-WR63; W-WR75; W-WR86; W-WR110)

**B14** (W63; W75; W86; W110)

INPUT STYLE

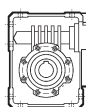

**S1**  
**S2**  
**S3**



**M**

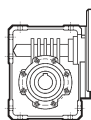

**P63**  
**P71**  
**P80**  
**P90**  
**P100/11**  
**2P132**

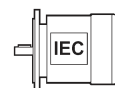

**IEC**

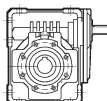

**HS**

GEAR RATIO

OUTPUT SHAFT BORE

Only for	W 75	<b>D30</b>	default
		<b>D28</b>	option

VERSION

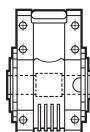

**U**  
(W63 ... W110)

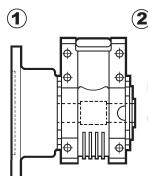

**UF1 - UF2**  
(W63 ... W110)

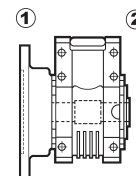

**UFC1 - UFC2**  
(W63 ... W110)  
**UFCR1 - UFCR2**  
(W75)

TORQUE LIMITER  
**L1, L2**

FRAME SIZE  
**63, 75, 86, 110**

SERIES

**W** = worm gearbox

**WR** = helical-worm gear units

## Speed reducer designation - Series VF/W, W/VF, VF/VF

**VF/W 30/63 L1 U — 1520 P63 B5 B3 CW1 .....**

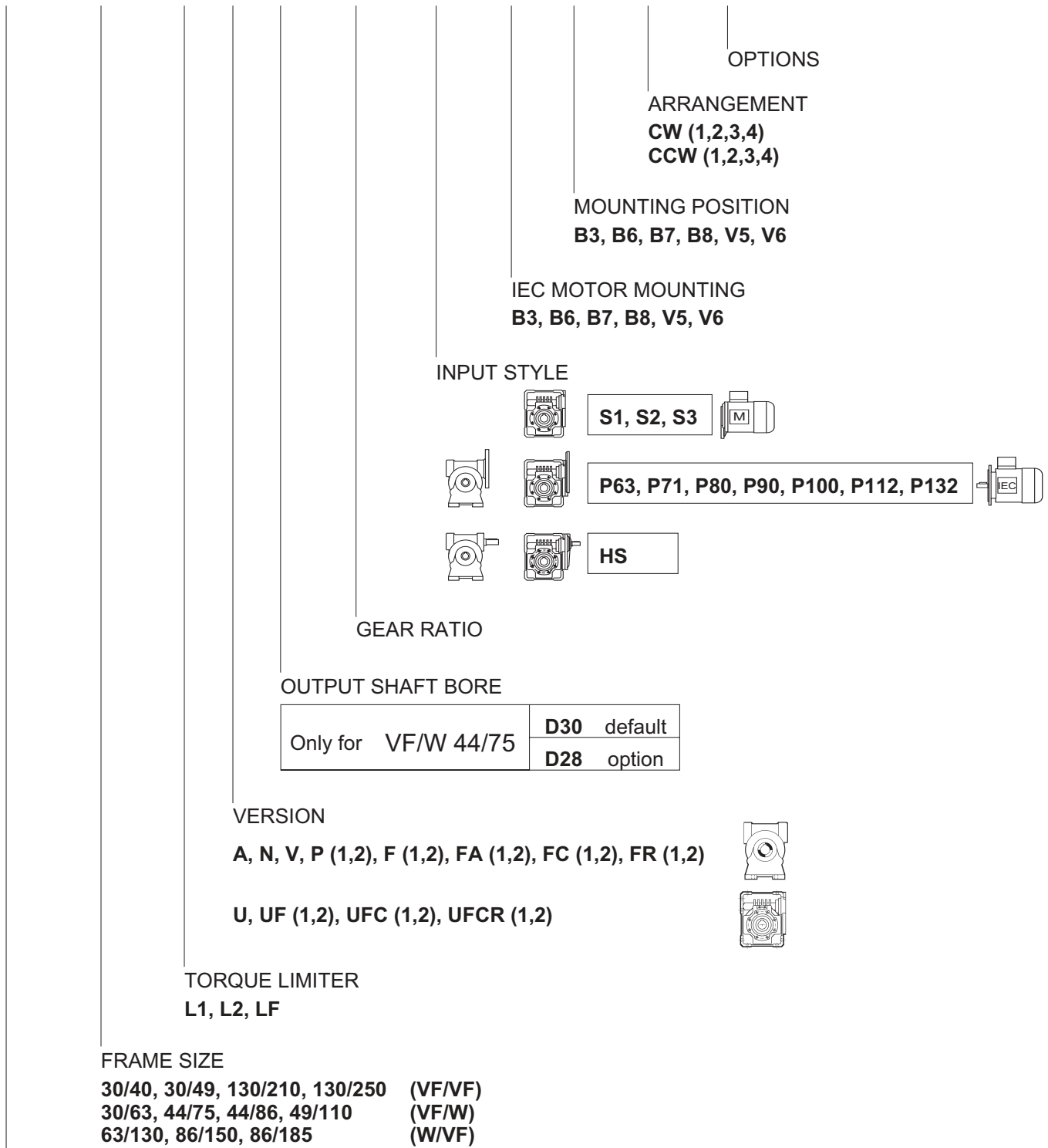

SERIES

**VF/VF, VF/W, W/VF** = double worm gear

# Bonfiglioli motor

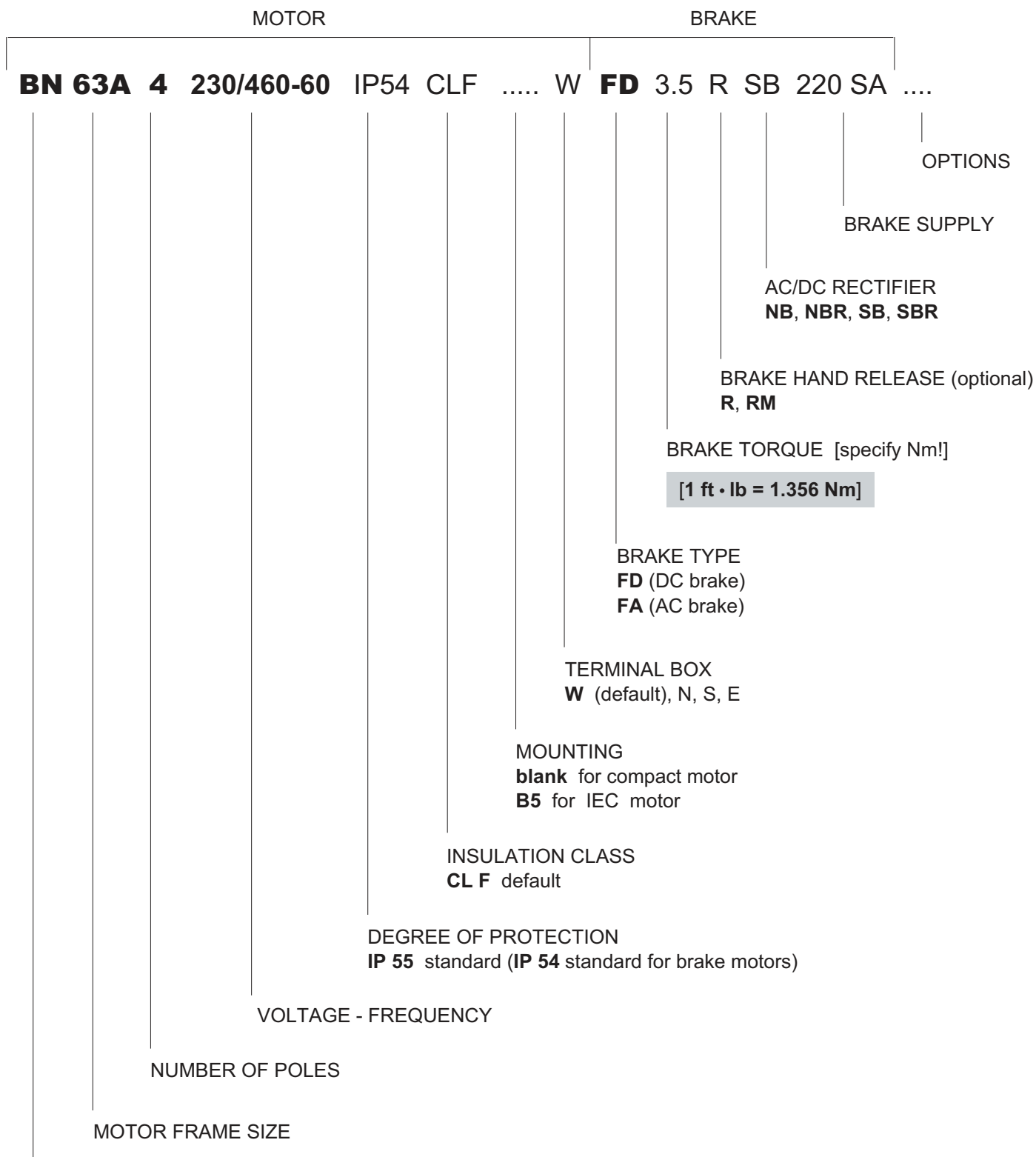

TYPE OF MOTOR



**M** = integral

**BN** = IEC flanged type

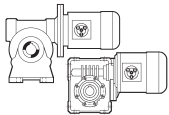
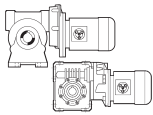
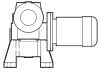

**NEMA** motors to be specified thru their ordering numbers

## GEARMOTOR SELECTION CHARTS

### 0.125 hp



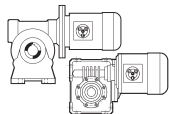
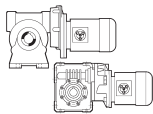
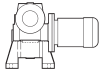

$n_2$ [rpm]	$T_2$ [lb·in]	<b>S</b> Safety factor	$i$ (ratio)	$R_{n2}$ [lb]					
236	28	2.9	7	92	<b>VF 27 – 7</b>			P27 BN27C4	n/a
165	38	2.1	10	112	<b>VF 27 – 10</b>			P27 BN27C4	n/a
165	39	3.7	10	173	<b>VF 30 – 10</b>			P56 BN56B4	N42CZ
110	54	1.5	15	135	<b>VF 27 – 15</b>			P27 BN27C4	n/a
110	54	2.9	15	205	<b>VF 30 – 15</b>			P56 BN56B4	N42CZ
83	68	1.2	20	135	<b>VF 27– 20</b>			P27 BN27C4	n/a
83	70	2.3	20	232	<b>VF 30 – 20</b>			P56 BN56B4	N42CZ
55	93	1.9	30	270	<b>VF 30 – 30</b>			P56 BN56B4	N42CZ
41.3	115	1.5	40	306	<b>VF 30 – 40</b>			P56 BN56B4	N42CZ
27.5	146	1.2	60	357	<b>VF 30 – 60</b>			P56 BN56B4	N42CZ
23.5	250	1.4	70	597		<b>VFR 44 – 70</b>		S44 BN44C4	n/a
16.5	326	1.4	100	597		<b>VFR 44 – 100</b>		S44 BN44C4	n/a
13.0	363	2.3	84	710		<b>VFR 49 – 84</b>		P63 BN63A6	<sup>3</sup>
9.5	477	1.2	175	597		<b>VFR 44 – 175</b>		S44 BN44C4	n/a
8.1	492	1.6	135	710		<b>VFR 49 – 135</b>		P63 BN63A6	<sup>3</sup>
6.9	539	3.5	240	1124			<b>VF/W 30/63 – 240</b>	P56 BN56B4	N42CZ
5.2	628	1.1	210	710		<b>VFR 49 – 210</b>			<sup>3</sup>
5.2	632	2.9	315	1124			<b>VF/W 30/63 – 315</b>	P56 BN56B4	N42CZ
3.7	881	2.1	450	1124			<b>VF/W 30/63 – 450</b>	P56 BN56B4	N42CZ
2.9	1089	1.7	570	1124			<b>VF/W 30/63 – 570</b>	P56 BN56B4	N42CZ
2.3	1272	1.5	720	1124			<b>VF/W 30/63 – 720</b>	P56 BN56B4	N42CZ
1.8	1289	1.4	900	1124			<b>VF/W 30/63 – 900</b>	P56 BN56B4	N42CZ
1.4	1375	1.4	1200	1124			<b>VF/W 30/63 – 1200</b>	P56 BN56B4	N42CZ
1.1	1742	1.1	1520	1124			<b>VF/W 30/63 – 1520</b>	P56 BN56B4	N42CZ

### 0.16 hp

$n_2$ [rpm]	$T_2$ [lb·in]	<b>S</b> Safety factor	$i$ (ratio)	$R_{n2}$ [lb]					
236	36	3.9	7	142	<b>VF 30 – 7</b>			P63 BN63A4	N42CZ
165	50	2.9	10	173	<b>VF 30 – 10</b>			P63 BN63A4	N42CZ
118	69	3.7	14	378	<b>VF 44 – 14</b>			P63 BN63A4	N56C
110	70	2.3	15	205	<b>VF 30 – 15</b>			P63 BN63A4	N42CZ
92	86	6.1	18	425	<b>VF 49 – 18</b>			P63 BN63A4	N56C

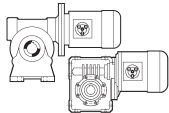
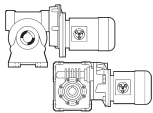

## 0.16 hp





$n_2$ [rpm]	$T_2$ [lb-in]	S Safety factor	i (ratio)	$R_{n2}$ [lb]					
83	89	1.8	20	232	VF 30 – 20			P63 BN63A4	N42CZ
83	94	3.7	20	418	VF 44 – 20			P63 BN63A4	N56C
59	121	2.8	28	481	VF 44 – 28			P63 BN63A4	N56C
55	119	1.5	30	270	VF 30 – 30			P63 BN63A4	N42CZ
47.1	145	2.4	35	517	VF 44 – 35			P63 BN63A4	N56C
41.3	147	1.1	40	306	VF 30 – 40			P63 BN63A4	N42CZ
39.3	190	3.6	42	562		VFR 49 – 42		P63 BN63A4	<sup>3</sup>
36.7	173	3.3	45	613	VF 49 – 45			P63 BN63A4	N56C
35.9	177	1.9	46	517	VF 44 – 46			P63 BN63A4	N56C
30.6	234	2.8	54	636		VFR 49 – 54		P63 BN63A4	<sup>3</sup>
27.5	213	1.6	60	517	VF 44 – 60			P63 BN63A4	N56C
27.5	213	2.5	60	697	VF 49 – 60			P63 BN63A4	N56C
23.6	235	1.1	70	517	VF 44 – 70			P63 BN63A4	N56C
23.6	231	2.1	70	708	VF 49 – 70			P63 BN63A4	N56C
22.9	295	2.2	72	717		VFR 49 – 72		P63 BN63A4	<sup>3</sup>
20.6	254	1.9	80	708	VF 49 – 80			P63 BN63A4	N56C
19.6	318	2.4	84	740		VFR 49 – 84		P63 BN63A4	<sup>3</sup>
16.5	287	1.5	100	708	VF 49 – 100			P63 BN63A4	N56C
15.3	383	1.8	108	776		VFR 49 – 108		P63 BN63A4	<sup>3</sup>
12.2	446	1.7	135	776		VFR 49 – 135		P63 BN63A4	<sup>3</sup>
9.2	528	1.2	180	776		VFR 49 – 180		P63 BN63A4	<sup>3</sup>
7.9	578	1.1	210	776		VFR 49 – 210		P63 BN63A4	<sup>3</sup>
6.9	660	1.3	240	776			VF/VF 30/49 – 240	P63 BN63A4	N42CZ
5.5	935	3.5	300	1160			VF/W 44/75 – 300	P63 BN63A4	N56C
5.2	770	1.1	315	776			VF/VF 30/49 – 315	P63 BN63A4	N42CZ
4.1	1125	2.9	400	1394			VF/W 44/75 – 400	P63 BN63A4	N56C
3.7	1128	1.6	450	1124			VF/W 30/63 – 450	P63 BN63A4	N42CZ
3.1	1412	2.3	525	1394			VF/W 44/75 – 525	P63 BN63A4	N56C
2.9	1393	1.3	570	1124			VF/W 30/63 – 570	P63 BN63A4	N42CZ
2.4	1797	1.8	700	1394			VF/W 44/75 – 700	P63 BN63A4	N56C
2.3	1628	1.1	720	1124			VF/W 30/63 – 720	P63 BN63A4	N42CZ
1.8	1650	1.1	900	1124			VF/W 30/63 – 900	P63 BN63A4	N42CZ
1.4	1760	1.1	1200	1124			VF/W 30/63 – 1200	P63 BN63A4	N42CZ
1.2	2475	3.6	1350	1798			VF/W 49/110 – 1350	P63 BN63A4	N56C
1.2	2699	1.6	1380	1574			VF/W 44/86 – 1380	P63 BN63A4	N56C
1.1	3392	1.0	1500	1394			VF/W 44/75 – 1500	P63 BN63A4	N56C
1.0	3036	2.9	1656	1798			VF/W 49/110 – 1656	P63 BN63A4	N56C
0.90	3374	1.3	1840	1574			VF/W 44/86 – 1840	P63 BN63A4	N56C
0.80	3542	2.5	2070	1798			VF/W 49/110 – 2070	P63 BN63A4	N56C
0.78	3621	1.2	2116	1574			VF/W 44/86 – 2116	P63 BN63A4	N56C
0.60	4048	1.1	2760	1574			VF/W 44/86 – 2760	P63 BN63A4	N56C
0.59	4107	2.2	2800	1798			VF/W 49/110 – 2800	P63 BN63A4	N56C

Dynamic efficiency included in output values



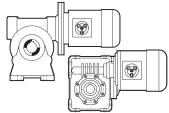
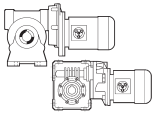

3 phase / 4 pole electric motor

 Refer to Notes after 20 hp section for <sup>1, 2, 3, 4</sup>



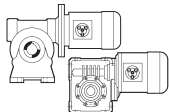
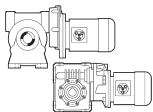

## 0.25 hp

$n_2$ [rpm]	$T_2$ [lb·in]	S Safety factor	i (ratio)	$R_{n2}$ [lb]					
239	53	2.7	7	142	VF 30 – 7			P63 BN63B4	N42CZ
239	54	4.7	7	265	VF 44 – 7			P63 BN63B4	N56C
167	73	1.9	10	173	VF 30 – 10			P63 BN63B4	N42CZ
167	76	3.4	10	321	VF 44 – 10			P63 BN63B4	N56C
119	102	2.5	14	378	VF 44 – 14			P63 BN63B4	N56C
111	103	1.6	15	205	VF 30 – 15			P63 BN63B4	N42CZ
93	126	4.1	18	425	VF 49 – 18			P63 BN63B4	N56C
84	131	1.2	20	232	VF 30 – 20			P63 BN63B4	N42CZ
84	139	2.5	20	418	VF 44 – 20			P63 BN63B4	N56C
70	162	3.4	24	474	VF 49 – 24			P63 BN63B4	N56C
60	179	1.9	28	481	VF 44 – 28			P63 BN63B4	N56C
56	176	1.0	30	270	VF 30 – 30			P63 BN63B4	N42CZ
47.7	214	1.6	35	517	VF 44 – 35			P63 BN63B4	N56C
46.4	217	2.8	36	553	VF 49 – 36			P63 BN63B4	N56C
39.8	280	2.5	42	562		VFR 49 – 42		P63 BN63B4	<sup>3</sup>
37.1	255	2.3	45	613	VF 49 – 45			P63 BN63B4	N56C
36.3	261	1.3	46	517	VF 44 – 46			P63 BN63B4	N56C
30.9	345	1.9	54	636		VFR 49 – 54		P63 BN63B4	<sup>3</sup>
27.8	313	1.1	60	517	VF 44 – 60			P63 BN63B4	N56C
23.9	340	1.4	70	708	VF 49 – 70			P63 BN63B4	N56C
23.2	434	1.5	72	717		VFR 49 – 72		P63 BN63B4	<sup>3</sup>
23.2	454	3.6	72	991		WR 63 – 72		P63 BN63B4	<sup>3</sup>
20.9	375	1.3	80	708	VF 49 – 80			P63 BN63B4	N56C
19.9	469	1.7	84	740		VFR 49 – 84		P63 BN63B4	<sup>3</sup>
18.6	519	3.2	90	1086		WR 63 – 90		P63 BN63B4	<sup>3</sup>
16.7	423	1.0	100	708	VF 49 – 100			P63 BN63B4	N56C
15.5	564	1.3	108	776		VFR 49 – 108		P63 BN63B4	<sup>3</sup>
12.4	656	1.2	135	776		VFR 49 – 135		P63 BN63B4	<sup>3</sup>
8.7	882	1.5	192	1124		WR 63 – 192		P63 BN63B4	<sup>3</sup>
7.0	994	1.2	240	1124		WR 63 – 240		P63 BN63B4	<sup>3</sup>
7.0	1016	1.8	240	1124			VF/W 30/63 – 240	P63 BN63B4	N42CZ
6.7	1283	2.6	250	1048			VF/W 44/75 – 250	P63 BN63B4	N56C
5.6	1107	1.0	300	1124		WR 63 – 300		P63 BN63B4	<sup>3</sup>
5.6	1378	2.4	300	1160			VF/W 44/75 – 300	P63 BN63B4	N56C
5.3	1191	1.6	315	1124			VF/W 30/63 – 315	P63 BN63B4	N42CZ
4.2	1657	2.0	400	1394			VF/W 44/75 – 400	P63 BN63B4	N56C
3.7	1661	1.1	450	1124			VF/W 30/63 – 450	P63 BN63B4	N42CZ
3.2	2080	1.6	525	1394			VF/W 44/75 – 525	P63 BN63B4	N56C
3.1	1993	4.4	540	1798			VF/W 49/110 – 540	P63 BN63B4	N56C
2.4	2647	1.2	700	1394			VF/W 44/75 – 700	P63 BN63B4	N56C
2.3	2593	3.4	720	1798			VF/W 49/110 – 720	P63 BN63B4	N56C
1.8	3313	1.0	920	1394			VF/W 44/75 – 920	P63 BN63B4	N56C



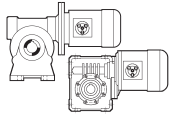
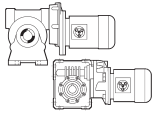

## 0.25 hp

$n_2$ [rpm]	$T_2$ [lb·in]	S Safety factor	i (ratio)	$R_{n2}$ [lb]				 <sup>1</sup>	 <sup>2</sup>
1.8	3313	1.3	920	1574			VF/W 44/86 – 920	P63 BN63B4	N56C
1.5	3014	2.9	1080	1798			VF/W 49/110 – 1080	P63 BN63B4	N56C
1.2	3646	2.4	1350	1798			VF/W 49/110 – 1350	P63 BN63B4	N56C
1.2	3976	1.1	1380	1574			VF/W 44/86 – 1380	P63 BN63B4	N56C
1.0	4473	2.0	1656	1798			VF/W 49/110 – 1656	P63 BN63B4	N56C
0.93	4538	3.5	1800	3102			W/VF 63/130 – 1800	P63 BN63B4	N56C
0.81	5218	1.7	2070	1798			VF/W 49/110 – 2070	P63 BN63B4	N56C
0.65	5301	3.0	2560	3102			W/VF 63/130 – 2560	P63 BN63B4	N56C
0.60	6050	1.5	2800	1798			VF/W 49/110 – 2800	P63 BN63B4	N56C
0.57	7157	3.2	2944	3597			W/VF 86/150 – 2944	P63 BN63B4	N56C
0.52	4898	3.3	3200	3102			W/VF 63/130 – 3200	P63 BN63B4	N56C



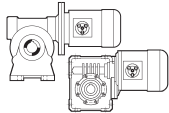
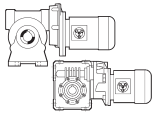

## 0.33 hp

$n_2$ [rpm]	$T_2$ [lb·in]	S Safety factor	i (ratio)	$R_{n2}$ [lb]				 <sup>1</sup>	 <sup>2</sup>
243	72	3.6	7	265	VF 44 – 7			P71 BN71A4	N56C
170	100	2.6	10	321	VF 44 – 10			P71 BN71A4	N56C
170	100	5.2	10	317	VF 49 – 10			P71 BN71A4	N56C
121	135	1.9	14	378	VF 44 – 14			P71 BN71A4	N56C
121	135	4.3	14	366	VF 49 – 14			P71 BN71A4	N56C
94	167	3.1	18	425	VF 49 – 18			P71 BN71A4	N56C
85	183	1.9	20	418	VF 44 – 20			P71 BN71A4	N56C
71	214	2.6	24	474	VF 49 – 24			P71 BN71A4	N56C
61	236	1.5	28	481	VF 44 – 28			P71 BN71A4	N56C
61	236	2.8	28	488	VF 49 – 28			P71 BN71A4	N56C
48.6	283	1.2	35	517	VF 44 – 35			P71 BN71A4	N56C
47.2	287	2.1	36	553	VF 49 – 36			P71 BN71A4	N56C
44.7	316	4.3	38	805	W 63 – 38			P71 BN71A4	N56C
40.5	369	1.9	42	562		VFR 49 – 42		P71 BN71A4	N56C <sup>3</sup>
37.8	337	1.7	45	613	VF 49 – 45			P71 BN71A4	N56C
37.8	358	3.6	45	881	W 63 – 45			P71 BN71A4	N56C
37.0	344	1.0	46	517	VF 44 – 46			P71 BN71A4	N56C
34.0	404	4.8	50	1216	W 75 – 50			P71 BN71A4	N56C
28.3	414	1.3	60	697	VF 49 – 60			P71 BN71A4	N56C
28.3	464	3.8	60	1340	W 75 – 60			P71 BN71A4	N56C
26.6	464	2.4	64	1052	W 63 – 64			P71 BN71A4	N56C
24.3	449	1.1	70	708	VF 49 – 70			P71 BN71A4	N56C
23.6	573	1.1	72	717		VFR 49 – 72		P71 BN71A4	N56C <sup>3</sup>
23.6	599	2.7	72	991		WR 63 – 72		P71 BN71A4	N56C <sup>3</sup>



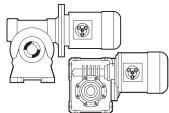
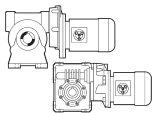

## 0.33 hp

$n_2$ [rpm]	$T_2$ [lb·in]	S Safety factor	i (ratio)	$R_{n2}$ [lb]						
21.3	494	1.0	80	708	VF 49 – 80			P71	BN71A4	N56C
21.3	532	1.9	80	1124	W 63 – 80			P71	BN71A4	N56C
21.3	561	2.8	80	1394	W 75 – 80			P71	BN71A4	N56C
20.2	619	1.3	84	740		VFR 49 – 84		P71	BN71A4	<sup>3</sup>
18.9	685	2.5	90	1086		WR 63 – 90		P71	BN71A4	<sup>3</sup>
17.0	606	1.7	100	1124	W 63 – 100			P71	BN71A4	N56C
17.0	654	2.0	100	1394	W 75 – 100			P71	BN71A4	N56C
17.0	701	2.9	100	1574	W 86 – 100			P71	BN71A4	N56C
15.7	744	1.0	108	776		VFR 49 – 108		P71	BN71A4	<sup>3</sup>
14.9	826	2.0	114	1124		WR 63 – 114		P71	BN71A4	<sup>3</sup>
14.2	898	3.0	120	1394		WR 75 – 120		P71	BN71A4	<sup>3</sup>
12.6	931	1.6	135	1124		WR 63 – 135		P71	BN71A4	<sup>3</sup>
11.3	1034	2.2	150	1394		WR 75 – 150		P71	BN71A4	<sup>3</sup>
10.1	1198	2.6	168	1574		WR 86 – 168		P71	BN71A4	<sup>3</sup>
9.4	1177	1.8	180	1394		WR 75 – 180		P71	BN71A4	<sup>3</sup>
8.9	1164	1.1	192	1124		WR 63 – 192		P71	BN71A4	<sup>3</sup>
8.9	1323	2.2	192	1574		WR 86 – 192		P71	BN71A4	<sup>3</sup>
7.4	1476	3.0	230	1574			VF/W 44/86 – 230	P71	BN71A4	N56C
7.1	1398	1.4	240	1394		WR 75 – 240		P71	BN71A4	<sup>3</sup>
7.1	1341	1.4	240	1124			VF/W 30/63 – 240	P71	BN71A4	N42CZ
6.8	1694	1.9	250	1048			VF/W 44/75 – 250	P71	BN71A4	N56C
5.7	1569	1.0	300	1394		WR 75 – 300		P71	BN71A4	<sup>3</sup>
5.7	1747	1.4	300	1574		WR 86 – 300		P71	BN71A4	<sup>3</sup>
5.7	1818	1.8	300	1160			VF/W 44/75 – 300	P71	BN71A4	N56C
4.3	2187	1.5	400	1394			VF/W 44/75 – 400	P71	BN71A4	N56C
4.3	1949	2.3	400	1574			VF/W 44/86 – 400	P71	BN71A4	N56C
3.2	2745	1.2	525	1394			VF/W 44/75 – 525	P71	BN71A4	N56C
3.1	2631	3.4	540	1798			VF/W 49/110 – 540	P71	BN71A4	N56C
2.8	2852	5.6	600	3102			W/VF 63/130 – 600	P71	BN71A4	N56C
2.4	3245	1.4	700	1574			VF/W 44/86 – 700	P71	BN71A4	N56C
2.2	3523	4.5	760	3102			W/VF 63/130 – 760	P71	BN71A4	N56C
1.8	4374	1.0	920	1574			VF/W 44/86 – 920	P71	BN71A4	N56C
1.6	3979	2.2	1080	1798			VF/W 49/110 – 1080	P71	BN71A4	N56C
1.4	4849	3.3	1200	3102			W/VF 63/130 – 1200	P71	BN71A4	N56C
1.3	4813	1.8	1350	1798			VF/W 49/110 – 1350	P71	BN71A4	N56C
1.1	5781	2.8	1520	3102			W/VF 63/130 – 1520	P71	BN71A4	N56C
1.0	5904	1.5	1656	1798			VF/W 49/110 – 1656	P71	BN71A4	N56C
0.94	5990	2.7	1800	3102			W/VF 63/130 – 1800	P71	BN71A4	N56C
0.92	8310	2.8	1840	3597			W/VF 86/150 – 1840	P71	BN71A4	N56C
0.82	6888	1.3	2070	1798			VF/W 49/110 – 2070	P71	BN71A4	N56C
0.66	6998	2.3	2560	3102			W/VF 63/130 – 2560	P71	BN71A4	N56C
0.61	7987	1.1	2800	1798			VF/W 49/110 – 2800	P71	BN71A4	N56C
0.58	9447	2.4	2944	3597			W/VF 86/150 – 2944	P71	BN71A4	N56C
0.53	6465	2.5	3200	3102			W/VF 63/130 – 3200	P71	BN71A4	N56C



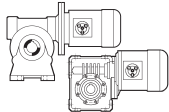
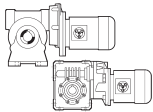

## 0.5 hp

$n_2$ [rpm]	$T_2$ [lb-in]	S Safety factor	i (ratio)	$R_{n2}$ [lb]					
243	108	2.4	7	265	VF 44 – 7			P71 BN71B4	N56C
170	151	1.7	10	321	VF 44 – 10			P71 BN71B4	N56C
170	151	3.5	10	317	VF 49 – 10			P71 BN71B4	N56C
121	204	1.3	14	378	VF 44 – 14			P71 BN71B4	N56C
121	204	2.8	14	366	VF 49 – 14			P71 BN71B4	N56C
94	253	2.1	18	425	VF 49 – 18			P71 BN71B4	N56C
85	277	1.2	20	418	VF 44 – 20			P71 BN71B4	N56C
71	324	1.7	24	474	VF 49 – 24			P71 BN71B4	N56C
61	358	1.0	28	481	VF 44 – 28			P71 BN71B4	N56C
61	358	1.8	28	488	VF 49 – 28			P71 BN71B4	N56C
57	400	3.5	30	713	W 63 – 30			P71 BN71B4	N56C
47.2	434	1.4	36	553	VF 49 – 36			P71 BN71B4	N56C
44.7	479	2.9	38	805	W 63 – 38			P71 BN71B4	N56C
37.8	511	1.1	45	613	VF 49 – 45			P71 BN71B4	N56C
37.8	616	2.6	45	796		WR 63 – 45		P71 BN71B4	N56C <sup>3</sup>
34.0	612	3.2	50	1216	W 75 – 50			P71 BN71B4	N56C
30.4	706	3.8	56	1574	W 86 – 56			P71 BN71B4	N56C
29.8	749	2.1	57	895		WR 63 – 57		P71 BN71B4	N56C <sup>3</sup>
28.3	702	2.5	60	1340	W 75 – 60			P71 BN71B4	N56C
26.6	703	1.6	64	1052	W 63 – 64			P71 BN71B4	N56C
24.6	932	3.6	69	1574		WR 86 – 69		P71 BN71B4	N56C <sup>3</sup>
23.6	908	1.8	72	991		WR 63 – 72		P71 BN71B4	N56C <sup>3</sup>
22.7	986	2.6	75	1324		WR 75 – 75		P71 BN71B4	N56C <sup>3</sup>
21.3	807	1.3	80	1124	W 63 – 80			P71 BN71B4	N56C
21.3	850	1.9	80	1394	W 75 – 80			P71 BN71B4	N56C
18.9	1037	1.6	90	1086		WR 63 – 90		P71 BN71B4	N56C <sup>3</sup>
18.9	1118	2.5	90	1394		WR 75 – 90		P71 BN71B4	N56C <sup>3</sup>
17.0	918	1.1	100	1124	W 63 – 100			P71 BN71B4	N56C
17.0	990	1.3	100	1394	W 75 – 100			P71 BN71B4	N56C
17.0	1062	1.9	100	1574	W 86 – 100			P71 BN71B4	N56C
14.9	1252	1.3	114	1124		WR 63 – 114		P71 BN71B4	N56C <sup>3</sup>
14.2	1361	2.0	120	1394		WR 75 – 120		P71 BN71B4	N56C <sup>3</sup>
12.6	1410	1.1	135	1124		WR 63 – 135		P71 BN71B4	N56C <sup>3</sup>
12.3	1566	2.3	138	1574		WR 86 – 138		P71 BN71B4	N56C <sup>3</sup>
11.3	1567	1.5	150	1394		WR 75 – 150		P71 BN71B4	N56C <sup>3</sup>
10.1	1815	1.7	168	1574		WR 86 – 168		P71 BN71B4	N56C <sup>3</sup>
9.4	1783	1.2	180	1394		WR 75 – 180		P71 BN71B4	N56C <sup>3</sup>
8.9	2005	1.5	192	1574		WR 86 – 192		P71 BN71B4	N56C <sup>3</sup>
7.4	2236	2.0	230	1574			VF/W 44/86 – 230	P71 BN71B4	N56C
7.1	2291	1.2	240	1574		WR 86 – 240		P71 BN71B4	N56C <sup>3</sup>
6.8	2566	1.3	250	1048			VF/W 44/75 – 250	P71 BN71B4	N56C
5.7	2755	1.2	300	1160			VF/W 44/75 – 300	P71 BN71B4	N56C
5.7	2431	1.8	300	1574			VF/W 44/86 – 300	P71 BN71B4	N56C



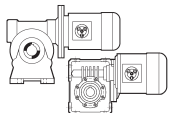
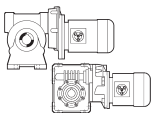

## 0.5 hp

$n_2$ [rpm]	$T_2$ [lb·in]	S Safety factor	i (ratio)	$R_{n2}$ [lb]					
4.3	3313	1.0	400	1394			<b>VF/W 44/75 – 400</b>	<b>P71 BN71B4</b>	<b>N56C</b>
4.3	2953	1.5	400	1574			<b>VF/W 44/86 – 400</b>	<b>P71 BN71B4</b>	<b>N56C</b>
3.2	3971	1.1	525	1574			<b>VF/W 44/86 – 525</b>	<b>P71 BN71B4</b>	<b>N56C</b>
3.1	3987	2.2	540	1798			<b>VF/W 49/110 – 540</b>	<b>P71 BN71B4</b>	<b>N56C</b>
2.8	4322	3.7	600	3102			<b>W/VF 63/130 – 600</b>	<b>P71 BN71B4</b>	<b>N56C</b>
2.5	6212	3.7	690	3597			<b>W/VF 86/150 – 690</b>	<b>P71 BN71B4</b>	<b>N56C</b>
2.4	5186	1.7	720	1798			<b>VF/W 49/110 – 720</b>	<b>P71 BN71B4</b>	<b>N56C</b>
2.2	5337	3.0	760	3102			<b>W/VF 63/130 – 760</b>	<b>P71 BN71B4</b>	<b>N56C</b>
1.8	6396	2.5	960	3102			<b>W/VF 63/130 – 960</b>	<b>P71 BN71B4</b>	<b>N56C</b>
1.6	6029	1.5	1080	1798			<b>VF/W 49/110 – 1080</b>	<b>P71 BN71B4</b>	<b>N56C</b>
1.4	7347	2.2	1200	3102			<b>W/VF 63/130 – 1200</b>	<b>P71 BN71B4</b>	<b>N56C</b>
1.3	7293	1.2	1350	1798			<b>VF/W 49/110 – 1350</b>	<b>P71 BN71B4</b>	<b>N56C</b>
1.2	10437	2.2	1380	3597			<b>W/VF 86/150 – 1380</b>	<b>P71 BN71B4</b>	<b>N56C</b>
1.1	8759	1.8	1520	3102			<b>W/VF 63/130 – 1520</b>	<b>P71 BN71B4</b>	<b>N56C</b>
1.0	8946	1.0	1656	1798			<b>VF/W 49/110 – 1656</b>	<b>P71 BN71B4</b>	<b>N56C</b>
0.94	9076	1.8	1800	3102			<b>W/VF 63/130 – 1800</b>	<b>P71 BN71B4</b>	<b>N56C</b>
0.92	12591	1.8	1840	3597			<b>W/VF 86/150 – 1840</b>	<b>P71 BN71B4</b>	<b>N56C</b>
0.66	10603	1.5	2560	3102			<b>W/VF 63/130 – 2560</b>	<b>P71 BN71B4</b>	<b>N56C</b>
0.58	14314	1.6	2944	3597			<b>W/VF 86/150 – 2944</b>	<b>P71 BN71B4</b>	<b>N56C</b>
0.53	9796	1.6	3200	3102			<b>W/VF 63/130 – 3200</b>	<b>P71 BN71B4</b>	<b>N56C</b>

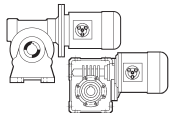
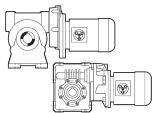

## 0.75 hp

$n_2$ [rpm]	$T_2$ [lb·in]	S Safety factor	i (ratio)	$R_{n2}$ [lb]					
244	163	2.9	7	263	<b>VF 49 – 7</b>			<b>P80 BN80A4</b>	<b>N56C</b>
171	227	2.3	10	317	<b>VF 49 – 10</b>			<b>P80 BN80A4</b>	<b>N56C</b>
122	306	1.9	14	366	<b>VF 49 – 14</b>			<b>P80 BN80A4</b>	<b>N56C</b>
114	336	3.9	15	513	<b>W 63 – 15</b>			<b>P80 BN80A4</b>	<b>N56C</b>
95	379	1.4	18	425	<b>VF 49 – 18</b>			<b>P80 BN80A4</b>	<b>N56C</b>
90	416	3.2	19	584	<b>W 63 – 19</b>			<b>P80 BN80A4</b>	<b>N56C</b>
86	448	4.9	20	767	<b>W 75 – 20</b>			<b>P80 BN80A4</b>	<b>N56C</b>
81	476	2.6	21	564		<b>WR 63 – 21</b>		<b>P80 BN80A4</b>	<b>N56C</b> <sup>3</sup>
71	486	1.1	24	474	<b>VF 49 – 24</b>			<b>P80 BN80A4</b>	<b>N56C</b>
71	506	2.7	24	650	<b>W 63 – 24</b>			<b>P80 BN80A4</b>	<b>N56C</b>
68	540	4.1	25	863	<b>W 75 – 25</b>			<b>P80 BN80A4</b>	<b>N56C</b>
61	537	1.2	28	488	<b>VF 49 – 28</b>			<b>P80 BN80A4</b>	<b>N56C</b>
57	600	2.4	30	713	<b>W 63 – 30</b>			<b>P80 BN80A4</b>	<b>N56C</b>
57	681	3.6	30	812		<b>WR 75 – 30</b>		<b>P80 BN80A4</b>	<b>N56C</b> <sup>3</sup>

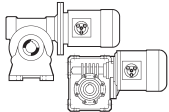
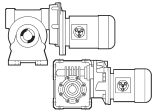
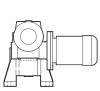

## 0.75 hp

$n_2$ [rpm]	$T_2$ [lb-in]	S Safety factor	i (ratio)	$R_{n2}$ [lb]					
45.0	718	1.9	38	805	W 63 – 38			P80 BN80A4	N56C
42.8	778	2.9	40	1072	W 75 – 40			P80 BN80A4	N56C
38.0	814	1.6	45	881	W 63 – 45			P80 BN80A4	N56C
38.0	972	2.7	45	1018		WR 75 – 45		P80 BN80A4	<sup>3</sup>
37.2	907	3.3	46	1574	W 86 – 46			P80 BN80A4	N56C
34.2	918	2.1	50	1216	W 75 – 50			P80 BN80A4	N56C
30.5	1059	2.5	56	1574	W 86 – 56			P80 BN80A4	N56C
28.5	1053	1.7	60	1340	W 75 – 60			P80 BN80A4	N56C
28.5	1248	2.1	60	1187		WR 75 – 60		P80 BN80A4	<sup>3</sup>
28.5	1248	2.7	60	1574		WR 86 – 60		P80 BN80A4	<sup>3</sup>
26.7	1054	1.0	64	1052	W 63 – 64			P80 BN80A4	N56C
26.7	1176	2.1	64	1574	W 86 – 64			P80 BN80A4	N56C
24.8	1398	2.4	69	1574		WR 86 – 69		P80 BN80A4	<sup>3</sup>
22.8	1479	1.8	75	1324		WR 75 – 75		P80 BN80A4	<sup>3</sup>
21.4	1275	1.2	80	1394	W 75 – 80			P80 BN80A4	N56C
21.4	1383	1.6	80	1574	W 86 – 80			P80 BN80A4	N56C
19.0	1677	1.7	90	1394		WR 75 – 90		P80 BN80A4	<sup>3</sup>
17.1	1594	1.3	100	1574	W 86 – 100			P80 BN80A4	N56C
17.1	1675	2.4	100	1798	W 110 – 100			P80 BN80A4	N56C
14.3	2042	1.3	120	1394		WR 75 – 120		P80 BN80A4	<sup>3</sup>
14.3	2139	1.6	120	1574		WR 86 – 120		P80 BN80A4	<sup>3</sup>
12.4	2348	1.5	138	1574		WR 86 – 138		P80 BN80A4	<sup>3</sup>
11.4	2350	1.0	150	1394		WR 75 – 150		P80 BN80A4	<sup>3</sup>
10.2	2723	1.2	168	1574		WR 86 – 168		P80 BN80A4	<sup>3</sup>
10.2	2859	2.2	168	1798		WR 110 – 168		P80 BN80A4	<sup>3</sup>
8.9	3008	1.0	192	1574		WR 86 – 192		P80 BN80A4	<sup>3</sup>
8.9	3112	1.8	192	1798		WR 110 – 192		P80 BN80A4	<sup>3</sup>
7.4	3230	2.7	230	1798			VF/W 49/110 – 230	P80 BN80A4	N56C
7.1	3630	1.4	240	1798		WR 110 – 240		P80 BN80A4	<sup>3</sup>
7.1	3695	2.8	240	3102		VFR 130 – 240		P80 BN80A4	<sup>3</sup>
6.1	3782	4.2	280	3102			W/VF 63/130 – 280	P80 BN80A4	N56C
5.7	4133	1.2	300	1798		WR 110 – 300		P80 BN80A4	<sup>3</sup>
5.7	3890	2.3	300	1798			VF/W 49/110 – 300	P80 BN80A4	N56C
5.7	4295	1.9	300	3102		VFR 130 – 300		P80 BN80A4	<sup>3</sup>
5.0	5405	4.3	345	3597			W/VF 86/150 – 345	P80 BN80A4	N56C
4.3	4862	1.8	400	1798			VF/W 49/110 – 400	P80 BN80A4	N56C
3.7	6834	3.4	460	3597			W/VF 86/150 – 460	P80 BN80A4	N56C
3.2	7859	2.9	529	3597			W/VF 86/150 – 529	P80 BN80A4	N56C
3.2	5980	1.5	540	1798			VF/W 49/110 – 540	P80 BN80A4	N56C
2.9	6483	2.5	600	3102			W/VF 63/130 – 600	P80 BN80A4	N56C
2.5	9319	2.5	690	3597			W/VF 86/150 – 690	P80 BN80A4	N56C
2.4	7779	1.1	720	1798			VF/W 49/110 – 720	P80 BN80A4	N56C
2.3	8006	2.0	760	3102			W/VF 63/130 – 760	P80 BN80A4	N56C

## 0.75 hp



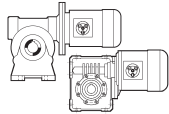
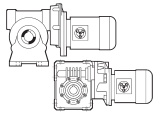
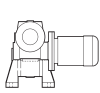

$n_2$ [rpm]	$T_2$ [lb·in]	S Safety factor	i (ratio)	$R_{n2}$ [lb]					
2.1	9292	4.0	800	4384			W/VF 86/185 – 800	P80 BN80A4	N56C
1.9	11182	2.1	920	3597			W/VF 86/150 – 920	P80 BN80A4	N56C
1.8	9594	1.7	960	3102			W/VF 63/130 – 960	P80 BN80A4	N56C
1.6	9043	1.0	1080	1798			VF/W 49/110 – 1080	P80 BN80A4	N56C
1.4	11020	1.4	1200	3102			W/VF 63/130 – 1200	P80 BN80A4	N56C
1.2	15655	1.5	1380	3597			W/VF 86/150 – 1380	P80 BN80A4	N56C
1.1	13138	1.2	1520	3102			W/VF 63/130 – 1520	P80 BN80A4	N56C
1.1	15126	2.5	1600	4384			W/VF 86/185 – 1600	P80 BN80A4	N56C
0.95	13613	1.2	1800	3102			W/VF 63/130 – 1800	P80 BN80A4	N56C
0.93	18886	1.2	1840	3597			W/VF 86/150 – 1840	P80 BN80A4	N56C
0.93	16898	2.2	1840	4384			W/VF 86/185 – 1840	P80 BN80A4	N56C
0.67	15904	1.0	2560	3102			W/VF 63/130 – 2560	P80 BN80A4	N56C
0.67	20053	1.9	2560	4384			W/VF 86/185 – 2560	P80 BN80A4	N56C
0.58	21470	1.1	2944	3597			W/VF 86/150 – 2944	P80 BN80A4	N56C
0.53	14694	1.1	3200	3102			W/VF 63/130 – 3200	P80 BN80A4	N56C
0.53	20744	1.8	3200	4384			W/VF 86/185 – 3200	P80 BN80A4	N56C

## 1 hp



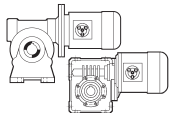
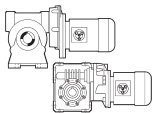

$n_2$ [rpm]	$T_2$ [lb·in]	S Safety factor	i (ratio)	$R_{n2}$ [lb]					
246	217	2.2	7	263	VF 49 – 7			P80 BN80B4	N56C
172	303	1.7	10	317	VF 49 – 10			P80 BN80B4	N56C
123	408	1.4	14	366	VF 49 – 14			P80 BN80B4	N56C
115	448	3.0	15	513	W 63 – 15			P80 BN80B4	N56C
96	506	1.0	18	425	VF 49 – 18			P80 BN80B4	N56C
91	554	2.4	19	584	W 63 – 19			P80 BN80B4	N56C
86	598	3.7	20	767	W 75 – 20			P80 BN80B4	N56C
82	650	3.1	21	688		WR 75 – 21		P80 BN80B4	N56C <sup>3</sup>
72	674	2.0	24	650	W 63 – 24			P80 BN80B4	N56C
69	720	3.1	25	863	W 75 – 25			P80 BN80B4	N56C
57	800	1.8	30	713	W 63 – 30			P80 BN80B4	N56C
57	908	2.7	30	812		WR 75 – 30		P80 BN80B4	N56C <sup>3</sup>
45.3	958	1.4	38	805	W 63 – 38			P80 BN80B4	N56C
43.0	1037	2.2	40	1072	W 75 – 40			P80 BN80B4	N56C
43.0	1080	2.7	40	1574	W 86 – 40			P80 BN80B4	N56C
38.2	1086	1.2	45	881	W 63 – 45			P80 BN80B4	N56C
38.2	1297	2.0	45	1018		WR 75 – 45		P80 BN80B4	N56C <sup>3</sup>
37.4	1209	2.5	46	1574	W 86 – 46			P80 BN80B4	N56C
34.4	1224	1.6	50	1216	W 75 – 50			P80 BN80B4	N56C





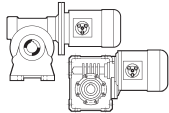
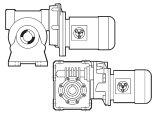

# 1 hp

$n_2$ [rpm]	$T_2$ [lb-in]	S Safety factor	i (ratio)	$R_{n2}$ [lb]				 <sup>1</sup>	 <sup>2</sup>
30.7	1412	1.9	56	1574	W 86 – 56			P80 BN80B4	N56C
28.7	1405	1.3	60	1340	W 75 – 60			P80 BN80B4	N56C
28.7	1664	1.6	60	1187		WR 75 – 60		P80 BN80B4	<sup>3</sup>
26.9	1567	1.6	64	1574	W 86 – 64			P80 BN80B4	N56C
26.9	1613	2.9	64	1798	W 110 – 64			P80 BN80B4	N56C
24.9	1864	1.8	69	1574		WR 86 – 69		P80 BN80B4	<sup>3</sup>
22.9	1972	1.3	75	1324		WR 75 – 75		P80 BN80B4	<sup>3</sup>
21.5	1844	1.2	80	1574	W 86 – 80			P80 BN80B4	N56C
21.5	1902	2.2	80	1798	W 110 – 80			P80 BN80B4	N56C
19.1	2236	1.3	90	1394		WR 75 – 90		P80 BN80B4	<sup>3</sup>
17.2	2125	1.0	100	1574	W 86 – 100			P80 BN80B4	N56C
17.2	2233	1.8	100	1798	W 110 – 100			P80 BN80B4	N56C
14.3	2723	1.0	120	1394		WR 75 – 120		P80 BN80B4	<sup>3</sup>
14.3	2852	1.2	120	1574		WR 86 – 120		P80 BN80B4	<sup>3</sup>
12.5	3131	1.1	138	1574		WR 86 – 138		P80 BN80B4	<sup>3</sup>
12.5	3280	1.9	138	1798		WR 110 – 138		P80 BN80B4	<sup>3</sup>
10.2	3812	1.6	168	1798		WR 110 – 168		P80 BN80B4	<sup>3</sup>
10.2	3872	2.7	168	3102		VFR 130 – 168		P80 BN80B4	<sup>3</sup>
9.0	4149	1.3	192	1798		WR 110 – 192		P80 BN80B4	<sup>3</sup>
9.0	4218	2.5	192	3102		VFR 130 – 192		P80 BN80B4	<sup>3</sup>
7.5	4307	2.1	230	1798			VF/W 49/110 – 230	P80 BN80B4	N56C
7.2	4840	1.0	240	1798		WR 110 – 240		P80 BN80B4	<sup>3</sup>
7.2	4927	2.1	240	3102		VFR 130 – 240		P80 BN80B4	<sup>3</sup>
6.1	5042	3.2	280	3102			W/VF 63/130 – 280	P80 BN80B4	N56C
5.7	5186	1.7	300	1798			VF/W 49/110 – 300	P80 BN80B4	N56C
5.7	5726	1.4	300	3102		VFR 130 – 300		P80 BN80B4	<sup>3</sup>
5.0	7206	3.2	345	3597			W/VF 86/150 – 345	P80 BN80B4	N56C
4.3	6483	1.4	400	1798			VF/W 49/110 – 400	P80 BN80B4	N56C
4.3	6339	2.5	400	3102			W/VF 63/130 – 400	P80 BN80B4	N56C
3.7	9112	2.5	460	3597			W/VF 86/150 – 460	P80 BN80B4	N56C
3.3	10478	2.2	529	3597			W/VF 86/150 – 529	P80 BN80B4	N56C
3.2	7974	1.1	540	1798			VF/W 49/110 – 540	P80 BN80B4	N56C
2.9	8643	1.8	600	3102			W/VF 63/130 – 600	P80 BN80B4	N56C
2.5	12425	1.9	690	3597			W/VF 86/150 – 690	P80 BN80B4	N56C
2.3	10675	1.5	760	3102			W/VF 63/130 – 760	P80 BN80B4	N56C
1.9	14910	1.5	920	3597			W/VF 86/150 – 920	P80 BN80B4	N56C
1.8	12792	1.2	960	3102			W/VF 63/130 – 960	P80 BN80B4	N56C
1.4	14694	1.1	1200	3102			W/VF 63/130 – 1200	P80 BN80B4	N56C
1.2	20874	1.1	1380	3597			W/VF 86/150 – 1380	P80 BN80B4	N56C
1.1	20168	1.8	1600	4384			W/VF 86/185 – 1600	P80 BN80B4	N56C
0.93	22531	1.6	1840	4384			W/VF 86/185 – 1840	P80 BN80B4	N56C
0.67	26737	1.4	2560	4384			W/VF 86/185 – 2560	P80 BN80B4	N56C
0.54	27659	1.3	3200	4384			W/VF 86/185 – 3200	P80 BN80B4	N56C



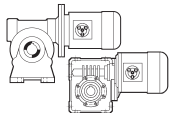
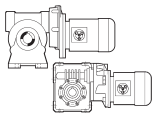

# 1.5 hp

$n_2$ [rpm]	$T_2$ [lb·in]	S Safety factor	i (ratio)	$R_{n2}$ [lb]				 <sup>1</sup>	 <sup>2</sup>
246	333	3.2	7	348	W 63 – 7			P90 BN90S4	N143TC
172	465	2.7	10	414	W 63 – 10			P90 BN90S4	N143TC
115	673	2.0	15	513	W 63 – 15			P90 BN90S4	N143TC
91	831	1.6	19	584	W 63 – 19			P90 BN90S4	N143TC
86	897	2.5	20	767	W 75 – 20			P90 BN90S4	N143TC
82	976	2.0	21	688		WR 75 – 21		P90 BN90S4	<sup>3</sup>
75	1019	2.8	23	1529	W 86 – 23			P90 BN90S4	N143TC
72	1011	1.4	24	650	W 63 – 24			P90 BN90S4	N143TC
69	1080	2.0	25	863	W 75 – 25			P90 BN90S4	N143TC
57	1199	1.2	30	713	W 63 – 30			P90 BN90S4	N143TC
57	1248	1.9	30	919	W 75 – 30			P90 BN90S4	N143TC
45.3	1437	1.0	38	805	W 63 – 38			P90 BN90S4	N143TC
43.0	1556	1.5	40	1072	W 75 – 40			P90 BN90S4	N143TC
43.0	1621	1.8	40	1574	W 86 – 40			P90 BN90S4	N143TC
38.2	1945	1.3	45	1018		WR 75 – 45		P90 BN90S4	<sup>3</sup>
37.4	1814	1.7	46	1574	W 86 – 46			P90 BN90S4	N143TC
34.4	1837	1.1	50	1216	W 75 – 50			P90 BN90S4	N143TC
30.7	2118	1.3	56	1574	W 86 – 56			P90 BN90S4	N143TC
30.7	2178	2.4	56	1798	W 110 – 56			P90 BN90S4	N143TC
28.7	2496	1.0	60	1187		WR 75 – 60		P90 BN90S4	<sup>3</sup>
26.9	2351	1.1	64	1574	W 86 – 64			P90 BN90S4	N143TC
26.9	2420	1.9	64	1798	W 110 – 64			P90 BN90S4	N143TC
24.9	2796	1.2	69	1574		WR 86 – 69		P90 BN90S4	<sup>3</sup>
21.5	2852	1.5	80	1798	W 110 – 80			P90 BN90S4	N143TC
19.1	3257	1.2	90	1574		WR 86 – 90		P90 BN90S4	<sup>3</sup>
17.2	3349	1.2	100	1798	W 110 – 100			P90 BN90S4	N143TC
14.3	4408	1.6	120	1798		WR 110 – 120		P90 BN90S4	<sup>3</sup>
14.3	4343	2.9	120	3102		VFR 130 – 120		P90 BN90S4	<sup>3</sup>
12.5	4920	1.3	138	1798		WR 110 – 138		P90 BN90S4	<sup>3</sup>
12.5	4995	2.4	138	3102		VFR 130 – 138		P90 BN90S4	<sup>3</sup>
10.2	5718	1.1	168	1798		WR 110 – 168		P90 BN90S4	<sup>3</sup>
10.2	5808	1.8	168	3102		VFR 130 – 168		P90 BN90S4	<sup>3</sup>
9.0	6327	1.7	192	3102		VFR 130 – 192		P90 BN90S4	<sup>3</sup>
7.6	7658	3.0	225	3597		W/VF 86/150 – 225		P90 BN90S4	N143TC
7.2	7390	1.4	240	3102		VFR 130 – 240		P90 BN90S4	<sup>3</sup>
7.2	7520	1.8	240	3597		VFR 150 – 240		P90 BN90S4	<sup>3</sup>
6.1	7563	2.1	280	3102		W/VF 63/130 – 280		P90 BN90S4	N143TC
5.7	9400	2.4	300	3597		W/VF 86/150 – 300		P90 BN90S4	N143TC
5.7	8751	1.3	300	3597		VFR 150 – 300		P90 BN90S4	<sup>3</sup>
5.0	10810	2.1	345	3597		W/VF 86/150 – 345		P90 BN90S4	N143TC
4.3	9508	1.7	400	3102		W/VF 63/130 – 400		P90 BN90S4	N143TC
3.7	13667	1.7	460	3597		W/VF 86/150 – 460		P90 BN90S4	N143TC
3.3	15718	1.5	529	3597		W/VF 86/150 – 529		P90 BN90S4	N143TC

## 1.5 hp

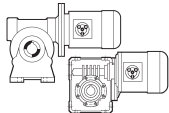
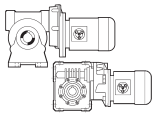
$n_2$ [rpm]	$T_2$ [lb·in]	S Safety factor	i (ratio)	$R_{n2}$ [lb]					
2.9	12965	1.2	600	3102			W/VF 63/130 – 600	P90 BN90S4	N143TC
2.9	14586	2.5	600	4384			W/VF 86/185 – 600	P90 BN90S4	N143TC
2.5	18637	1.2	690	3597			W/VF 86/150 – 690	P90 BN90S4	N143TC
2.3	16012	1.0	760	3102			W/VF 63/130 – 760	P90 BN90S4	N143TC
2.2	18583	2.0	800	4384			W/VF 86/185 – 800	P90 BN90S4	N143TC
1.9	22365	1.0	920	3597			W/VF 86/150 – 920	P90 BN90S4	N143TC
1.9	20874	1.8	920	4384			W/VF 86/185 – 920	P90 BN90S4	N143TC
1.4	22041	1.7	1200	4384			W/VF 86/185 – 1200	P90 BN90S4	N143TC
1.1	30252	1.2	1600	4384			W/VF 86/185 – 1600	P90 BN90S4	N143TC
0.93	33796	1.1	1840	4384			W/VF 86/185 – 1840	P90 BN90S4	N143TC
0.67	33191	1.7	2560	7756			VF/VF 130/210 – 2560	P90 BN90S4	N143TC
0.54	38031	1.5	3200	7756			VF/VF 130/210 – 3200	P90 BN90S4	N143TC

## 2 hp





$n_2$ [rpm]	$T_2$ [lb·in]	S Safety factor	i (ratio)	$R_{n2}$ [lb]					
246	444	2.4	7	348	W 63 – 7			P90 BN90LA4	N145TC
172	619	2.0	10	414	W 63 – 10			P90 BN90LA4	N145TC
115	897	1.5	15	513	W 63 – 15			P90 BN90LA4	N145TC
115	918	2.4	15	645	W 75 – 15			P90 BN90LA4	N145TC
91	1109	1.2	19	584	W 63 – 19			P90 BN90LA4	N145TC
86	1196	1.9	20	767	W 75 – 20			P90 BN90LA4	N145TC
86	1210	2.3	20	1434	W 86 – 20			P90 BN90LA4	N145TC
82	1301	1.5	21	688		WR 75 – 21		P90 BN90LA4	N145TC <sup>3</sup>
72	1348	1.0	24	650	W 63 – 24			P90 BN90LA4	N145TC
69	1441	1.5	25	863	W 75 – 25			P90 BN90LA4	N145TC
57	1664	1.4	30	919	W 75 – 30			P90 BN90LA4	N145TC
57	1815	1.3	30	812		WR 75 – 30		P90 BN90LA4	N145TC <sup>3</sup>
43.0	2161	1.4	40	1574	W 86 – 40			P90 BN90LA4	N145TC
38.2	2593	1.0	45	1018		WR 75 – 45		P90 BN90LA4	N145TC <sup>3</sup>
38.2	2528	1.4	45	1574		WR 86 – 45		P90 BN90LA4	N145TC <sup>3</sup>
37.4	2419	1.2	46	1574	W 86 – 46			P90 BN90LA4	N145TC
37.4	2452	2.2	46	1798	W 110 – 46			P90 BN90LA4	N145TC
30.7	2904	1.8	56	1798	W 110 – 56			P90 BN90LA4	N145TC
28.7	3328	1.0	60	1574		WR 86 – 60		P90 BN90LA4	N145TC <sup>3</sup>
28.7	3414	1.7	60	1798		WR 110 – 60		P90 BN90LA4	N145TC <sup>3</sup>
26.9	3227	1.5	64	1798	W 110 – 64			P90 BN90LA4	N145TC
24.9	3827	1.5	69	1798		WR 110 – 69		P90 BN90LA4	N145TC <sup>3</sup>
21.5	3803	1.1	80	1798	W 110 – 80			P90 BN90LA4	N145TC

Dynamic efficiency included in output values



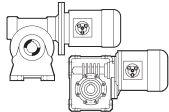
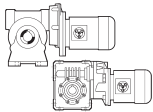

3 phase / 4 pole electric motor

Refer to Notes after 20 hp section for <sup>1, 2, 3, 4</sup>



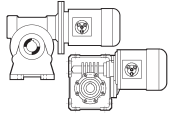
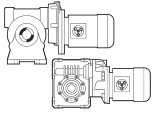

## 2 hp

$n_2$ [rpm]	$T_2$ [lb·in]	S Safety factor	i (ratio)	$R_{n2}$ [lb]					
19.1	4538	1.6	90	1798	VF 130 – 100	WR 110 – 90		P90 BN90LA4	3
19.1	4603	2.9	90	3102		VFR 130 – 90		P90 BN90LA4	3
17.2	4610	1.5	100	2832				P90 BN90LA4	N145TC
14.3	5878	1.2	120	1798		WR 110 – 120		P90 BN90LA4	3
14.3	5791	2.1	120	3102		VFR 130 – 120		P90 BN90LA4	3
12.5	6560	1.0	138	1798		WR 110 – 138		P90 BN90LA4	3
12.5	6660	1.8	138	3102		VFR 130 – 138		P90 BN90LA4	3
10.2	7745	1.4	168	3102		VFR 130 – 168		P90 BN90LA4	3
10.2	7866	2.0	168	3597		VFR 150 – 168		P90 BN90LA4	3
9.0	8436	1.3	192	3102		VFR 130 – 192		P90 BN90LA4	3
9.0	8574	1.8	192	3597	VFR 150 – 192		P90 BN90LA4	3	
8.6	9220	2.5	200	3597			W/VF 86/150 – 200	P90 BN90LA4	N145TC
7.6	10210	2.3	225	3597			W/VF 86/150 – 225	P90 BN90LA4	N145TC
7.2	9854	1.0	240	3102			VFR 130 – 240	P90 BN90LA4	3
7.2	10026	1.4	240	3597			VFR 150 – 240	P90 BN90LA4	3
6.1	10084	1.6	280	3102			W/VF 63/130 – 280	P90 BN90LA4	N145TC
5.7	12533	1.8	300	3597			W/VF 86/150 – 300	P90 BN90LA4	N145TC
5.7	11669	1.0	300	3597		VFR 150 – 300	P90 BN90LA4	3	
5.0	14413	1.6	345	3597			W/VF 86/150 – 345	P90 BN90LA4	N145TC
4.3	12677	1.3	400	3102			W/VF 63/130 – 400	P90 BN90LA4	N145TC
3.7	18223	1.3	460	3597			W/VF 86/150 – 460	P90 BN90LA4	N145TC
3.3	20957	1.1	529	3597			W/VF 86/150 – 529	P90 BN90LA4	N145TC
2.9	19448	1.9	600	4384			W/VF 86/185 – 600	P90 BN90LA4	N145TC
2.2	24778	1.5	800	4384			W/VF 86/185 – 800	P90 BN90LA4	N145TC
1.9	27832	1.3	920	4384			W/VF 86/185 – 920	P90 BN90LA4	N145TC
1.1	36879	2.2	1600	11690			VF/VF 130/250 – 1600	P90 BN90LA4	N145TC
0.93	39760	1.4	1840	7756			VF/VF 130/210 – 1840	P90 BN90LA4	N145TC
0.93	41085	1.9	1840	11690			VF/VF 130/250 – 1840	P90 BN90LA4	N145TC
0.67	44254	1.3	2560	7756			VF/VF 130/210 – 2560	P90 BN90LA4	N145TC
0.67	46098	1.7	2560	11690			VF/VF 130/250 – 2560	P90 BN90LA4	N145TC
0.54	50708	1.1	3200	7756			VF/VF 130/210 – 3200	P90 BN90LA4	N145TC



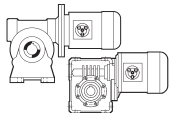
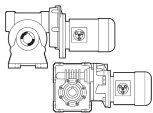

## 3 hp

$n_2$ [rpm]	$T_2$ [lb·in]	S Safety factor	i (ratio)	$R_{n2}$ [lb]					
246	681	2.5	7	344	W 75 – 7			P100 BN100LA4	N182TC
172	951	2.1	10	504	W 75 – 10			P100 BN100LA4	N182TC
115	1378	1.6	15	645	W 75 – 15			P100 BN100LA4	N182TC
86	1794	1.2	20	767	W 75 – 20			P100 BN100LA4	N182TC
86	1815	1.6	20	1434	W 86 – 20			P100 BN100LA4	N182TC



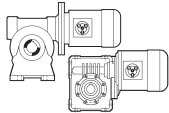
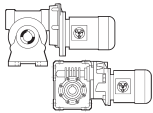

### 3 hp

$n_2$ [rpm]	$T_2$ [lb-in]	S Safety factor	i (ratio)	$R_{n2}$ [lb]					
75	2038	1.4	23	1529	W 86 – 23			P100 BN100LA4	N182TC
75	2063	2.3	23	1798	W 110 – 23			P100 BN100LA4	N182TC
69	2161	1.0	25	863	W 75 – 25			P100 BN100LA4	N182TC
57	2496	1.0	30	919	W 75 – 30			P100 BN100LA4	N182TC
57	2463	1.3	30	1574	W 86 – 30			P100 BN100LA4	N182TC
57	2723	2.1	30	1798		WR 110 – 30		P100 BN100LA4	<sup>3</sup>
43.0	3285	1.8	40	1798	W 110 – 40			P100 BN100LA4	N182TC
38.2	3890	1.6	45	1798		WR 110 – 45		P100 BN100LA4	<sup>3</sup>
37.4	3678	1.4	46	1798	W 110 – 46			P100 BN100LA4	N182TC
37.4	3777	2.5	46	2832	VF 130 – 46			P100 BN100LA4	-
30.7	4356	1.2	56	1798	W 110 – 56			P100 BN100LA4	N182TC
30.7	4417	1.9	56	2832	VF 130 – 56			P100 BN100LA4	N182TC
28.7	4797	4.2	60	4046	VF 185 – 60			P100 BN100LA4	N182TC
28.7	5121	1.2	60	1798		WR 110 – 60		P100 BN100LA4	<sup>3</sup>
28.7	5056	2.4	60	3102		VFR 130 – 60		P100 BN100LA4	<sup>3</sup>
26.9	4840	1.0	64	1798	W 110 – 64			P100 BN100LA4	N182TC
26.9	4909	1.7	64	2832	VF 130 – 64			P100 BN100LA4	N182TC
24.9	5740	1.0	69	1798		WR 110 – 69		P100 BN100LA4	<sup>3</sup>
24.9	5666	2.0	69	3102		VFR 130 – 69		P100 BN100LA4	<sup>3</sup>
21.5	5878	1.3	80	2832	VF 130 – 80			P100 BN100LA4	N182TC
21.5	5964	1.9	80	3305	VF 150 – 80			P100 BN100LA4	N182TC
19.1	6807	1.1	90	1798		WR 110 – 90		P100 BN100LA4	<sup>3</sup>
19.1	6904	1.9	90	3102		VFR 130 – 90		P100 BN100LA4	<sup>3</sup>
17.2	6915	1.0	100	2832	VF 130 – 100			P100 BN100LA4	N182TC
17.2	7023	1.4	100	3305	VF 150 – 100			P100 BN100LA4	N182TC
14.3	8687	1.4	120	3102		VFR 130 – 120		P100 BN100LA4	<sup>3</sup>
14.3	8816	2.0	120	3597		VFR 150 – 120		P100 BN100LA4	<sup>3</sup>
12.5	9990	1.2	138	3102		VFR 130 – 138		P100 BN100LA4	<sup>3</sup>
12.5	10139	1.7	138	3597		VFR 150 – 138		P100 BN100LA4	<sup>3</sup>
11.5	10858	3.7	150	7756		VFR 210 – 150		P100 BN100LA4	<sup>3</sup>
10.2	11798	1.3	168	3597		VFR 150 – 168		P100 BN100LA4	<sup>3</sup>
9.6	12447	3.1	180	7756		VFR 210 – 180		P100 BN100LA4	<sup>3</sup>
9.0	12861	1.2	192	3597		VFR 150 – 192		P100 BN100LA4	<sup>3</sup>
8.6	13829	1.7	200	3597		W/VF 86/150 – 200		P100 BN100LA4	N182TC
7.6	15315	1.5	225	3597		W/VF 86/150 – 225		P100 BN100LA4	N182TC
7.2	15299	2.3	240	7756		VFR 210 – 240		P100 BN100LA4	<sup>3</sup>
6.1	15126	1.1	280	3102		W/VF 63/130 – 280		P100 BN100LA4	N182TC
6.1	15731	2.4	280	4384		W/VF 86/185 – 280		P100 BN100LA4	N182TC
5.7	18799	1.2	300	3597		W/VF 86/150 – 300		P100 BN100LA4	N182TC
5.7	17827	1.7	300	7756		VFR 210 – 300		P100 BN100LA4	<sup>3</sup>
4.3	20744	1.8	400	4384		W/VF 86/185 – 400		P100 BN100LA4	N182TC
2.9	29172	1.3	600	4384		W/VF 86/185 – 600		P100 BN100LA4	N182TC
2.2	37167	1.0	800	4384		W/VF 86/185 – 800		P100 BN100LA4	N182TC



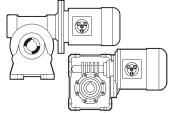
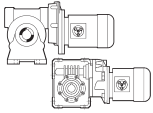

### 3 hp

$n_2$ [rpm]	$T_2$ [lb·in]	S Safety factor	i (ratio)	$R_{n2}$ [lb]					
2.2	35438	1.6	800	7756			VF/VF 130/210 – 800	P100 BN100LA4	N182TC
1.9	36778	1.5	920	7756			VF/VF 130/210 – 920	P100 BN100LA4	N182TC
1.4	45378	1.2	1200	7756			VF/VF 130/210 – 1200	P100 BN100LA4	N182TC
1.1	55318	1.0	1600	7756			VF/VF 130/210 – 1600	P100 BN100LA4	N182TC
1.1	55318	1.4	1600	11690			VF/VF 130/250 – 1600	P100 BN100LA4	N182TC
0.93	61628	1.3	1840	11690			VF/VF 130/250 – 1840	P100 BN100LA4	N182TC
0.67	69147	1.2	2560	11690			VF/VF 130/250 – 2560	P100 BN100LA4	N182TC
0.54	72605	1.1	3200	11690			VF/VF 130/250 – 3200	P100 BN100LA4	N182TC



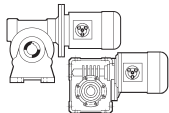
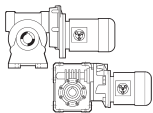

### 5 hp

$n_2$ [rpm]	$T_2$ [lb·in]	S Safety factor	i (ratio)	$R_{n2}$ [lb]					
247	1134	1.5	7	344	W 75 – 7			P112 BN112M4	N184TC
173	1585	1.3	10	504	W 75 – 10			P112 BN112M4	N184TC
173	1585	1.6	10	1039	W 86 – 10			P112 BN112M4	N184TC
115	2296	1.0	15	645	W 75 – 15			P112 BN112M4	N184TC
115	2296	1.3	15	1239	W 86 – 15			P112 BN112M4	N184TC
87	3025	1.7	20	1798	W 110 – 20			P112 BN112M4	N184TC
82	3252	1.6	21	1787		WR 110 – 21		P112 BN112M4	<sup>3</sup>
75	3438	1.4	23	1798	W 110 – 23			P112 BN112M4	N184TC
75	3438	2.3	23	2594	VF 130 – 23			P112 BN112M4	N184TC
58	4160	1.5	30	1798	W 110 – 30			P112 BN112M4	N184TC
58	4538	1.3	30	1798		WR 110 – 30		P112 BN112M4	<sup>3</sup>
43.3	5474	1.1	40	1798	W 110 – 40			P112 BN112M4	N184TC
43.3	5474	1.8	40	2832	VF 130 – 40			P112 BN112M4	N184TC
38.4	6483	1.0	45	1798		WR 110 – 45		P112 BN112M4	<sup>3</sup>
38.4	6645	2.3	45	3278		VFR 150 – 45		P112 BN112M4	<sup>3</sup>
37.6	6295	1.5	46	2832	VF 130 – 46			P112 BN112M4	N184TC
37.6	6378	2.2	46	3305	VF 150 – 46			P112 BN112M4	N184TC
34.6	6843	3.2	50	4046	VF 185 – 50			P112 BN112M4	N184TC
30.9	7361	1.2	56	2832	VF 130 – 56			P112 BN112M4	N184TC
30.9	7462	1.6	56	3305	VF 150 – 56			P112 BN112M4	N184TC
28.8	7995	2.5	60	4046	VF 185 – 60			P112 BN112M4	N184TC
28.8	8427	1.4	60	3102		VFR 130 – 60		P112 BN112M4	<sup>3</sup>
27.0	8182	1.0	64	2832	VF 130 – 64			P112 BN112M4	N184TC
27.0	8298	1.4	64	3305	VF 150 – 64			P112 BN112M4	N184TC
25.1	9443	1.2	69	3102		VFR 130 – 69		P112 BN112M4	<sup>3</sup>
25.1	9567	1.7	69	3597		VFR 150 – 69		P112 BN112M4	<sup>3</sup>
21.6	9940	1.1	80	3305	VF 150 – 80			P112 BN112M4	N184TC



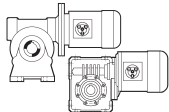
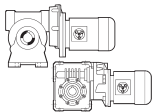

## 5 hp

$n_2$ [rpm]	$T_2$ [lb-in]	<b>S</b> Safety factor	$i$ (ratio)	$R_{n2}$ [lb]					
21.6	9940	1.9	80	4046	<b>VF 185 – 80</b>			<b>P112 BN112M4</b>	<b>N184TC</b>
19.2	11507	1.2	90	3102		<b>VFR 130 – 90</b>		<b>P112 BN112M4</b>	<sup>3</sup>
19.2	11669	1.5	90	3597		<b>VFR 150 – 90</b>		<b>P112 BN112M4</b>	<sup>3</sup>
17.3	11705	1.4	100	4046	<b>VF 185 – 100</b>			<b>P112 BN112M4</b>	<b>N184TC</b>
14.4	14694	1.2	120	3597		<b>VFR 150 – 120</b>		<b>P112 BN112M4</b>	<sup>3</sup>
12.5	16898	1.0	138	3597		<b>VFR 150 – 138</b>		<b>P112 BN112M4</b>	<sup>3</sup>
11.5	18097	2.2	150	7756		<b>VFR 210 – 150</b>		<b>P112 BN112M4</b>	<sup>3</sup>
9.6	20744	1.8	180	7756		<b>VFR 210 – 180</b>		<b>P112 BN112M4</b>	<sup>3</sup>
8.7	23049	1.0	200	3597			<b>W/VF 86/150 – 200</b>	<b>P112 BN112M4</b>	<b>N184TC</b>
7.2	25498	1.4	240	7756		<b>VFR 210 – 240</b>		<b>P112 BN112M4</b>	<sup>3</sup>
7.2	26362	1.8	240	11690		<b>VFR 250 – 240</b>		<b>P112 BN112M4</b>	<sup>3</sup>
6.2	26218	1.4	280	4384			<b>W/VF 86/185 – 280</b>	<b>P112 BN112M4</b>	<b>N184TC</b>
6.2	26218	2.1	280	7756			<b>VF/VF 130/210 – 280</b>	<b>P112 BN112M4</b>	<b>N184TC</b>
5.8	29712	1.0	300	7756		<b>VFR 210 – 300</b>		<b>P112 BN112M4</b>	<sup>3</sup>
5.8	30792	1.4	300	11690		<b>VFR 250 – 300</b>		<b>P112 BN112M4</b>	<sup>3</sup>
4.3	34574	1.1	400	4384			<b>W/VF 86/185 – 400</b>	<b>P112 BN112M4</b>	<b>N184TC</b>
2.9	46458	1.2	600	7756			<b>VF/VF 130/210 – 600</b>	<b>P112 BN112M4</b>	<b>N184TC</b>
2.2	60504	1.3	800	11690			<b>VF/VF 130/250 – 800</b>	<b>P112 BN112M4</b>	<b>N184TC</b>
1.9	61296	1.3	920	11690			<b>VF/VF 130/250 – 920</b>	<b>P112 BN112M4</b>	<b>N184TC</b>
1.4	75630	1.1	1200	11690			<b>VF/VF 130/250 – 1200</b>	<b>P112 BN112M4</b>	<b>N184TC</b>



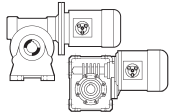
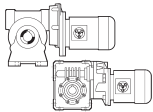

## 7.5 hp

$n_2$ [rpm]	$T_2$ [lb-in]	<b>S</b> Safety factor	$i$ (ratio)	$R_{n2}$ [lb]					
115	3484	2.3	15	2046	<b>VF 130 – 15</b>			<b>P132 BN132S4</b>	<b>N213TC</b>
87	4538	1.8	20	2412	<b>VF 130 – 20</b>			<b>P132 BN132S4</b>	<b>N213TC</b>
75	5156	1.5	23	2594	<b>VF 130 – 23</b>			<b>P132 BN132S4</b>	<b>N213TC</b>
75	5156	2.2	23	2763	<b>VF 150 – 23</b>			<b>P132 BN132S4</b>	<b>N213TC</b>
58	6402	1.5	30	2814	<b>VF 130 – 30</b>			<b>P132 BN132S4</b>	<b>N213TC</b>
43.3	8211	1.2	40	2832	<b>VF 130 – 40</b>			<b>P132 BN132S4</b>	<b>N213TC</b>
38.4	9967	1.5	45	3278		<b>VFR 150 – 45</b>		<b>P132 BN132S4</b>	<sup>3</sup>
37.6	9443	1.0	46	2832	<b>VF 130 – 46</b>			<b>P132 BN132S4</b>	<b>N213TC</b>
37.6	9567	1.4	46	3305	<b>VF 150 – 46</b>			<b>P132 BN132S4</b>	<b>N213TC</b>
34.6	10264	2.2	50	4046	<b>VF 185 – 50</b>			<b>P132 BN132S4</b>	<b>N213TC</b>
30.9	11193	1.1	56	3305	<b>VF 150 – 56</b>			<b>P132 BN132S4</b>	<b>N213TC</b>
28.8	11993	1.7	60	4046	<b>VF 185 – 60</b>			<b>P132 BN132S4</b>	<b>N213TC</b>
28.8	12803	1.3	60	3597		<b>VFR 150 – 60</b>		<b>P132 BN132S4</b>	<sup>3</sup>
25.1	14351	1.1	69	3597		<b>VFR 150 – 69</b>		<b>P132 BN132S4</b>	<sup>3</sup>
21.6	14910	1.3	80	4046	<b>VF 185 – 80</b>			<b>P132 BN132S4</b>	<b>N213TC</b>

## 7.5 hp

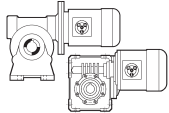
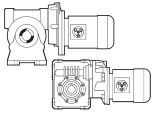



$n_2$ [rpm]	$T_2$ [lb·in]	S Safety factor	i (ratio)	$R_{n2}$ [lb]					
21.6	14910	1.7	80	7081	<b>VF 210 – 80</b>			<b>P132 BN132S4</b>	<b>N213TC</b>
19.2	17503	1.0	90	3597		<b>VFR 150 – 90</b>		<b>P132 BN132S4</b>	<sup>3</sup>
19.2	18475	1.9	90	7756		<b>VFR 210 – 90</b>		<b>P132 BN132S4</b>	<sup>3</sup>
17.3	17557	1.0	100	4046	<b>VF 185 – 100</b>			<b>P132 BN132S4</b>	<b>N213TC</b>
17.3	17557	1.4	100	7081	<b>VF 210 – 100</b>			<b>P132 BN132S4</b>	<b>N213TC</b>
14.4	22689	2.0	120	7756		<b>VFR 210 – 120</b>		<b>P132 BN132S4</b>	<sup>3</sup>
11.5	27146	1.5	150	7756		<b>VFR 210 – 150</b>		<b>P132 BN132S4</b>	<sup>3</sup>
9.6	31116	1.2	180	7756		<b>VFR 210 – 180</b>		<b>P132 BN132S4</b>	<sup>3</sup>
7.2	39544	1.2	240	11690		<b>VFR 250 – 240</b>		<b>P132 BN132S4</b>	<sup>3</sup>
6.2	39328	1.4	280	7756			<b>VF/VF 130/210 – 280</b>	<b>P132 BN132S4</b>	<b>N213TC</b>
6.2	40084	2.0	280	11690			<b>VF/VF 130/250 – 280</b>	<b>P132 BN132S4</b>	<b>N213TC</b>
5.8	46188	1.0	300	11690		<b>VFR 250 – 300</b>		<b>P132 BN132S4</b>	<sup>3</sup>
4.3	54021	1.0	400	7756			<b>VF/VF 130/210 – 400</b>	<b>P132 BN132S4</b>	<b>N213TC</b>
4.3	52941	1.5	400	11690			<b>VF/VF 130/250 – 400</b>	<b>P132 BN132S4</b>	<b>N213TC</b>
2.9	71308	1.1	600	11690			<b>VF/VF 130/250 – 600</b>	<b>P132 BN132S4</b>	<b>N213TC</b>

## 10 hp



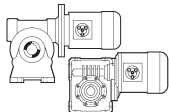
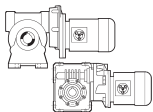

$n_2$ [rpm]	$T_2$ [lb·in]	S Safety factor	i (ratio)	$R_{n2}$ [lb]					
174	3169	2.2	10	1713	<b>VF 130 – 10</b>			<b>P132 BN132MA4</b>	<b>N215TC</b>
116	4646	1.8	15	2046	<b>VF 130 – 15</b>			<b>P132 BN132MA4</b>	<b>N215TC</b>
87	6050	1.3	20	2412	<b>VF 130 – 20</b>			<b>P132 BN132MA4</b>	<b>N215TC</b>
87	6050	1.9	20	2542	<b>VF 150 – 20</b>			<b>P132 BN132MA4</b>	<b>N215TC</b>
76	6875	1.1	23	2594	<b>VF 130 – 23</b>			<b>P132 BN132MA4</b>	<b>N215TC</b>
76	6875	1.6	23	2763	<b>VF 150 – 23</b>			<b>P132 BN132MA4</b>	<b>N215TC</b>
58	8535	1.1	30	2814	<b>VF 130 – 30</b>			<b>P132 BN132MA4</b>	<b>N215TC</b>
43.5	11092	1.2	40	3305	<b>VF 150 – 40</b>			<b>P132 BN132MA4</b>	<b>N215TC</b>
38.7	13289	1.1	45	3278		<b>VFR 150 – 45</b>		<b>P132 BN132MA4</b>	<sup>3</sup>
37.8	12756	1.1	46	3305	<b>VF 150 – 46</b>			<b>P132 BN132MA4</b>	<b>N215TC</b>
34.8	13685	1.6	50	4046	<b>VF 185 – 50</b>			<b>P132 BN132MA4</b>	<b>N215TC</b>
34.8	13685	2.1	50	7081	<b>VF 210 – 50</b>			<b>P132 BN132MA4</b>	<b>N215TC</b>
29.0	15990	1.3	60	4046	<b>VF 185 – 60</b>			<b>P132 BN132MA4</b>	<b>N215TC</b>
29.0	17071	1.0	60	3597		<b>VFR 150 – 60</b>		<b>P132 BN132MA4</b>	<sup>3</sup>
21.8	19880	1.3	80	7081	<b>VF 210 – 80</b>			<b>P132 BN132MA4</b>	<b>N215TC</b>
21.8	20456	1.7	80	10566	<b>VF 250 – 80</b>			<b>P132 BN132MA4</b>	<b>N215TC</b>
19.3	24634	1.4	90	7756		<b>VFR 210 – 90</b>		<b>P132 BN132MA4</b>	<sup>3</sup>
17.4	23409	1.0	100	7081	<b>VF 210 – 100</b>			<b>P132 BN132MA4</b>	<b>N215TC</b>





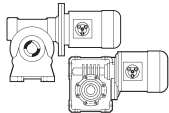
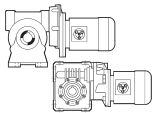

## 10 hp

$n_2$ [rpm]	$T_2$ [lb-in]	<b>S</b> Safety factor	$i$ (ratio)	$R_{n2}$ [lb]					
17.4	24490	1.3	100	10566	<b>VF 250 – 100</b>	<b>VFR 210 – 120</b>		<b>P132 BN132MA4</b>	<b>N215TC</b> 3
14.5	30252	1.5	120	7756					
14.5	30684	2.0	120	11690					
11.6	36194	1.1	150	7756					
11.6	36194	1.6	150	11690					
9.7	43433	1.3	180	11690					
6.2	52437	1.1	280	7756	<b>VFR 250 – 180</b>	<b>VF/VE 130/210 – 280</b>	<b>P132 BN132MA4</b>	<b>N215TC</b>	
6.2	53445	1.5	280	11690					
4.4	70588	1.1	400	11690					
						<b>VF/VE 130/250 – 280</b>	<b>P132 BN132MA4</b>	<b>N215TC</b>	
						<b>VF/VE 130/250 – 400</b>	<b>P132 BN132MA4</b>	<b>N215TC</b>	

## 15 hp

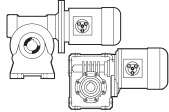
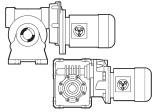
$n_2$ [rpm]	$T_2$ [lb-in]	<b>S</b> Safety factor	$i$ (ratio)	$R_{n2}$ [lb]					
117	7050	1.4	15	2246	<b>VF 150 – 15</b>	<b>VFR 210 – 45</b>		<b>P160 BN160M4</b>	n/a
88	9076	1.3	20	2542	<b>VF 150 – 20</b>				
76	10313	1.1	23	2763	<b>VF 150 – 23</b>				
58	13451	1.3	30	3808	<b>VF 185 – 30</b>				
58	13451	2.0	30	7081	<b>VF 210 – 30</b>				
43.8	16855	1.4	40	4028	<b>VF 185 – 40</b>				
43.8	16855	1.8	40	7081	<b>VF 210 – 40</b>				
38.9	20177	1.8	45	7457					
35.0	20528	1.1	50	4046	<b>VF 185 – 50</b>				
35.0	20528	1.4	50	7081	<b>VF 210 – 50</b>				
29.2	23661	1.1	60	7081	<b>VF 210 – 60</b>	<b>VFR 210 – 60</b>		<b>P160 BN160M4</b>	n/a
29.2	24634	1.6	60	10566	<b>VF 250 – 60</b>				
29.2	25930	1.6	60	7756					
21.9	30684	1.1	80	10566	<b>VF 250 – 80</b>				
19.4	36951	1.0	90	7756					
19.4	37923	1.4	90	11690		<b>VFR 210 – 90</b>	<b>P160 BN160M4</b>	n/a	
14.6	45378	1.0	120	7756		<b>VFR 250 – 90</b>	<b>P160 BN160M4</b>	n/a	
14.6	46026	1.3	120	11690		<b>VFR 210 – 120</b>	<b>P160 BN160M4</b>	n/a	
14.6	46026	1.3	120	11690		<b>VFR 250 – 120</b>	<b>P160 BN160M4</b>	n/a	
11.7	54292	1.1	150	11690		<b>VFR 210 – 150</b>	<b>P160 BN160M4</b>	n/a	
6.3	80168	1.0	280	11690			<b>VF/VE 130/250 – 280</b>	<b>P160 BN160M4</b>	n/a

## 20 hp

$n_2$ [rpm]	$T_2$ [lb·in]	<b>S</b> Safety factor	<b>i</b> (ratio)	$R_{n2}$ [lb]				 <sup>1</sup>	 <sup>2</sup>
175	6339	1.5	10	1825	<b>VF 150 – 10</b>			<b>P160 BN160L4</b>	n/a
117	9400	1.1	15	2246	<b>VF 150 – 15</b>			<b>P160 BN160L4</b>	n/a
117	9508	1.7	15	2608	<b>VF 185 – 15</b>			<b>P160 BN160L4</b>	n/a
88	12101	1.0	20	2542	<b>VF 150 – 20</b>			<b>P160 BN160L4</b>	n/a
88	12245	1.6	20	2904	<b>VF 185 – 20</b>			<b>P160 BN160L4</b>	n/a
58	17935	1.0	30	3808	<b>VF 185 – 30</b>			<b>P160 BN160L4</b>	n/a
58	17935	1.5	30	7081	<b>VF 210 – 30</b>			<b>P160 BN160L4</b>	n/a
43.8	22473	1.0	40	4028	<b>VF 185 – 40</b>			<b>P160 BN160L4</b>	n/a
43.8	22473	1.4	40	7081	<b>VF 210 – 40</b>			<b>P160 BN160L4</b>	n/a
38.9	26903	1.3	45	7457		<b>VFR 210 – 45</b>		<b>P160 BN160L4</b>	n/a
35.0	27371	1.5	50	10566	<b>VF 250 – 50</b>			<b>P160 BN160L4</b>	n/a
29.2	32845	1.2	60	10566	<b>VF 250 – 60</b>			<b>P160 BN160L4</b>	n/a
29.2	34574	1.2	60	7756		<b>VFR 210 – 60</b>		<b>P160 BN160L4</b>	n/a
29.2	35006	1.8	60	10372		<b>VFR 250 – 60</b>		<b>P160 BN160L4</b>	n/a
19.4	50564	1.1	90	11690		<b>VFR 250 – 90</b>		<b>P160 BN160L4</b>	n/a
14.6	61368	1.0	120	11690		<b>VFR 250 – 120</b>		<b>P160 BN160L4</b>	n/a

NOTES: <sup>1</sup> for motors BN27, BN44 and BN 56 add IF option for extra insulation for inverter duty

<sup>2</sup> Nema Input Table:	VF30	N 42CZ	(all ratios)	W75, W86	N 56C (all ratios)
	VF44	N 56C	(all ratios)	N 143-145TC	(all ratios)
	VF49	N 56C	(all ratios)	N 182-184TC	(all ratios)
	W63	N 56C	(all ratios)	W110	N 143-145TC (all ratios)
		N 143-145TC	(ratios 7:1 to 38:1)	N 182-184TC	(all ratios)
				N 213-215TC	(all ratios)

<sup>3</sup> for VFR & WR with Nema input see IEC adaptor for conversion to Nema "C"

<sup>4</sup> for Nema 213-215TC or VF 130-VF250, use P132 input plus ENTN213TC (see IEC adaptor for conversion to Nema "C")

## SPEED REDUCER RATING CHARTS

### VF 27

**80 lb·in**

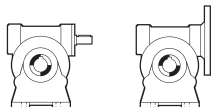
	$n_1 = 1750$ rpm (4 pole motor)							
	<b>i</b> (ratio)	$\eta_s$ (%)	$\eta_d$ (%)	<b>n<sub>2</sub></b> [rpm]	<b>T<sub>n2</sub></b> [lb·in]	<b>P<sub>n1</sub></b> [hp]	<b>R<sub>n1</sub></b> [lb]	<b>R<sub>n2</sub></b> [lb]
<b>VF 27 – 7</b>	7	67	83	250	80	0.38	8	92
<b>VF 27 – 10</b>	10	62	80	175	80	0.28	7	112
<b>VF 27 – 15</b>	15	54	75	117	80	0.20	—	135
<b>VF 27 – 20</b>	20	49	71	88	80	0.16	—	135
<b>VF 27 – 30</b>	30	38	62	58	80	0.12	—	135
<b>VF 27 – 40</b>	40	33	57	44	80	0.10	—	135
<b>VF 27 – 60</b>	60	26	49	29	80	0.08	—	135
<b>VF 27 – 70</b>	70	24	45	25	80	0.07	—	135

### VF 30

**177 lb·in**

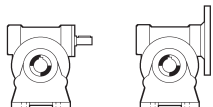
	$n_1 = 1750$ rpm (4 pole motor)							
	<b>i</b> (ratio)	$\eta_s$ (%)	$\eta_d$ (%)	<b>n<sub>2</sub></b> [rpm]	<b>T<sub>n2</sub></b> [lb·in]	<b>P<sub>n1</sub></b> [hp]	<b>R<sub>n1</sub></b> [lb]	<b>R<sub>n2</sub></b> [lb]
<b>VF 30 – 7</b>	7	69	84	250	142	0.67	31	142
<b>VF 30 – 10</b>	10	64	81	175	142	0.49	18	173
<b>VF 30 – 15</b>	15	56	76	117	159	0.39	—	205
<b>VF 30 – 20</b>	20	51	73	88	159	0.30	—	232
<b>VF 30 – 30</b>	30	41	65	58	177	0.25	—	270
<b>VF 30 – 40</b>	40	36	60	44	168	0.19	—	306
<b>VF 30 – 60</b>	60	29	51	29	168	0.15	—	357
<b>VF 30 – 70</b>	70	26	48	25	133	0.11	—	360

## VF 44

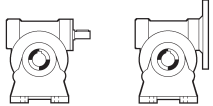
**345 lb·in**

		$n_1 = 1750 \text{ rpm (4 pole motor)}$							
		<b>i</b> (ratio)	$\eta_s$ (%)	$\eta_d$ (%)	$n_2$ [rpm]	$T_{n2}$ [lb·in]	$P_{n1}$ [hp]	$R_{n1}$ [lb]	$R_{n2}$ [lb]
<b>VF 44 – 7</b>		7	71	86	250	257	1.18	49	265
<b>VF 44 – 10</b>		10	66	84	175	257	0.85	49	321
<b>VF 44 – 14</b>		14	60	81	125	257	0.63	49	378
<b>VF 44 – 20</b>		20	55	77	88	345	0.62	49	418
<b>VF 44 – 28</b>		28	45	71	63	345	0.48	49	481
<b>VF 44 – 35</b>		35	42	68	50	345	0.40	49	517
<b>VF 44 – 46</b>		46	37	63	38	345	0.33	49	517
<b>VF 44 – 60</b>		60	32	58	29	345	0.28	—	517
<b>VF 44 – 70</b>		70	30	55	25	257	0.19	49	517
<b>VF 44 – 100</b>		100	24	47	18	248	0.15	49	517

## VF/VF 30/44

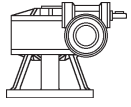
**531 lb·in**

		$n_1 = 1750 \text{ rpm (4 pole motor)}$							
		<b>i</b> (ratio)	$\eta_s$ (%)	$\eta_d$ (%)	$n_2$ [rpm]	$T_{n2}$ [lb·in]	$P_{n1}$ [hp]	$R_{n1}$ [lb]	$R_{n2}$ [lb]
<b>VF/VF 30/44 – 245</b>		245	29	40	7.1	531	0.15	31	562
<b>VF/VF 30/44 – 350</b>		350	27	36	5.0	531	0.12	18	562
<b>VF/VF 30/44 – 420</b>		420	25	35	4.2	531	0.10	—	562
<b>VF/VF 30/44 – 560</b>		560	23	31	3.1	531	0.08	—	562
<b>VF/VF 30/44 – 700</b>		700	21	31	2.5	531	0.07	—	562
<b>VF/VF 30/44 – 840</b>		840	18	26	2.1	531	0.07	—	562
<b>VF/VF 30/44 – 1120</b>		1120	16	26	1.6	531	0.05	—	562
<b>VF/VF 30/44 – 1680</b>		1680	13	26	1.0	531	0.03	—	562
<b>VF/VF 30/44 – 2100</b>		2100	12	21	0.8	531	0.03	—	562

## VF 49

**655 lb·in**

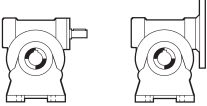
	$n_1 = 1750$ rpm (4 pole motor)							
	i (ratio)	$\eta_s$ (%)	$\eta_d$ (%)	$n_2$ [rpm]	$T_{n2}$ [lb·in]	$P_{n1}$ [hp]	$R_{n1}$ [lb]	$R_{n2}$ [lb]
VF 49 – 7	7	70	86	250	478	2.20	90	263
VF 49 – 10	10	65	84	175	522	1.73	90	317
VF 49 – 14	14	59	81	125	575	1.41	90	366
VF 49 – 18	18	55	78	97	522	1.03	90	425
VF 49 – 24	24	50	75	73	558	0.86	90	474
VF 49 – 28	28	43	71	63	655	0.91	49	488
VF 49 – 36	36	39	67	49	611	0.70	90	553
VF 49 – 45	45	35	63	39	575	0.56	90	613
VF 49 – 60	60	30	58	29	522	0.42	90	697
VF 49 – 70	70	28	54	25	487	0.36	90	708
VF 49 – 80	80	25	52	22	478	0.32	90	708
VF 49 – 100	100	22	47	18	434	0.26	90	708

## VFR 49

**779 lb·in**

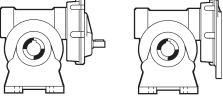
	$n_1 = 1750$ rpm (4 pole motor)							
	i (ratio)	$\eta_s$ (%)	$\eta_d$ (%)	$n_2$ [rpm]	$T_{n2}$ [lb·in]	$P_{n1}$ [hp]	$R_{n1}$ [lb]	$R_{n2}$ [lb]
VFR 49 – 42	42	58	74	41.7	690	0.62	52	562
VFR 49 – 54	54	54	71	32.4	655	0.47	52	636
VFR 49 – 72	72	49	67	24.3	655	0.38	—	717
VFR 49 – 84	84	42	62	20.8	779	0.42	—	740
VFR 49 – 108	108	38	58	16.2	708	0.31	—	776
VFR 49 – 135	135	34	54	13.0	779	0.30	—	776
VFR 49 – 180	180	29	48	9.7	611	0.20	—	776
VFR 49 – 210	210	27	45	8.3	611	0.18	—	776
VFR 49 – 240	240	25	42	7.3	522	0.14	52	776
VFR 49 – 300	300	22	37	5.8	522	0.13	52	776

## VF/VF 30/49

**841 lb·in**

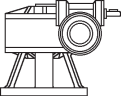
	$n_1 = 1750$ rpm (4 pole motor)							
	i (ratio)	$\eta_s$ (%)	$\eta_d$ (%)	$n_2$ [rpm]	$T_{n2}$ [lb·in]	$P_{n1}$ [hp]	$R_{n1}$ [lb]	$R_{n2}$ [lb]
VF/VF 30/49 – 240	240	32	45	7.3	841	0.22	18	776
VF/VF 30/49 – 315	315	24	40	5.6	841	0.19	31	776
VF/VF 30/49 – 420	420	24	41	4.2	841	0.14	—	776
VF/VF 30/49 – 540	540	22	37	3.2	841	0.12	—	776
VF/VF 30/49 – 720	720	20	39	2.4	841	0.08	—	776
VF/VF 30/49 – 900	900	18	31	1.9	841	0.08	—	776
VF/VF 30/49 – 1120	1120	15	31	1.6	841	0.07	—	776
VF/VF 30/49 – 1440	1440	14	24	1.2	841	0.07	—	776
VF/VF 30/49 – 2160	2160	11	21	0.8	841	0.05	—	776
VF/VF 30/49 – 2700	2700	10	17	0.6	841	0.05	—	776

Dynamic efficiency included in output values

## W 63

**1416 lb·in**

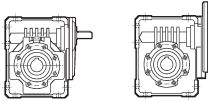
	$n_1 = 1750 \text{ rpm (4 pole motor)}$							
	<b>i</b> (ratio)	$\eta_s$ (%)	$\eta_d$ (%)	<b>n<sub>2</sub></b> [rpm]	<b>T<sub>n2</sub></b> [lb·in]	<b>P<sub>n1</sub></b> [hp]	<b>R<sub>n1</sub></b> [lb]	<b>R<sub>n2</sub></b> [lb]
<b>W 63 – 7</b>	7	70	88	250	1062	4.79	108	348
<b>W 63 – 10</b>	10	66	86	175	1239	4.00	108	414
<b>W 63 – 12</b>	12	63	85	145	1239	3.85	108	466
<b>W 63 – 15</b>	15	59	83	117	1328	2.96	108	513
<b>W 63 – 19</b>	19	55	81	92	1328	2.40	108	584
<b>W 63 – 24</b>	24	52	78	73	1372	2.03	108	650
<b>W 63 – 30</b>	30	44	74	58	1416	1.77	108	713
<b>W 63 – 38</b>	38	40	70	46	1372	1.43	108	805
<b>W 63 – 45</b>	45	37	67	39	1283	1.18	108	881
<b>W 63 – 64</b>	64	31	61	27	1106	0.79	108	1052
<b>W 63 – 80</b>	80	27	56	22	1018	0.63	108	1124
<b>W 63 – 100</b>	100	23	51	18	1018	0.55	108	1124

## WR 63

**1682 lb·in**

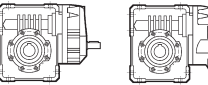
	$n_1 = 1750 \text{ rpm (4 pole motor)}$							
	<b>i</b> (ratio)	$\eta_s$ (%)	$\eta_d$ (%)	<b>n<sub>2</sub></b> [rpm]	<b>T<sub>n2</sub></b> [lb·in]	<b>P<sub>n1</sub></b> [hp]	<b>R<sub>n1</sub></b> [lb]	<b>R<sub>n2</sub></b> [lb]
<b>WR 63 – 21</b>	21	69	84	83.3	1239	1.95	72	564
<b>WR 63 – 30</b>	30	65	81	58.3	1460	1.67	72	656
<b>WR 63 – 36</b>	36	62	79	48.6	1460	1.42	72	728
<b>WR 63 – 45</b>	45	58	76	38.9	1593	1.29	72	796
<b>WR 63 – 57</b>	57	54	73	30.7	1593	1.06	72	895
<b>WR 63 – 72</b>	72	51	70	24.3	1637	0.90	72	991
<b>WR 63 – 90</b>	90	44	64	19.4	1682	0.81	72	1086
<b>WR 63 – 114</b>	114	39	61	15.4	1637	0.65	72	1124
<b>WR 63 – 135</b>	135	36	58	13.0	1505	0.53	—	1124
<b>WR 63 – 192</b>	192	30	51	9.1	1328	0.38	72	1124
<b>WR 63 – 240</b>	240	26	46	7.3	1195	0.30	72	1124
<b>WR 63 – 300</b>	300	22	41	5.8	1151	0.26	72	1124

## VF/W 30/63

**1859 lb·in**

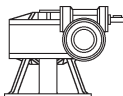
	$n_1 = 1750 \text{ rpm (4 pole motor)}$							
	<b>i</b> (ratio)	$\eta_s$ (%)	$\eta_d$ (%)	<b>n<sub>2</sub></b> [rpm]	<b>T<sub>n2</sub></b> [lb·in]	<b>P<sub>n1</sub></b> [hp]	<b>R<sub>n1</sub></b> [lb]	<b>R<sub>n2</sub></b> [lb]
<b>VF/W 30/63 – 240</b>	240	33	47	7.3	1859	0.46	18	1124
<b>VF/W 30/63 – 315</b>	315	26	42	5.6	1859	0.39	31	1124
<b>VF/W 30/63 – 450</b>	450	25	41	3.9	1859	0.28	—	1124
<b>VF/W 30/63 – 570</b>	570	22	40	3.1	1859	0.23	—	1124
<b>VF/W 30/63 – 720</b>	720	21	37	2.4	1859	0.19	—	1124
<b>VF/W 30/63 – 900</b>	900	18	30	1.9	1859	0.19	—	1124
<b>VF/W 30/63 – 1200</b>	1200	16	24	1.5	1859	0.18	—	1124
<b>VF/W 30/63 – 1520</b>	1520	14	24	1.2	1859	0.14	—	1124
<b>VF/W 30/63 – 2280</b>	2280	12	21	0.8	1859	0.11	—	1124
<b>VF/W 30/63 – 2700</b>	2700	11	22	0.6	1859	0.09	—	1124

Dynamic efficiency included in output values

## W 75

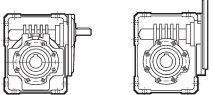
**2390 lb·in**

	$n_1 = 1750$ rpm (4 pole motor)							
	<b>i</b> (ratio)	$\eta_s$ (%)	$\eta_d$ (%)	$n_2$ [rpm]	$T_{n2}$ [lb·in]	$P_{n1}$ [hp]	$R_{n1}$ [lb]	$R_{n2}$ [lb]
<b>W 75 - 7</b>	7	71	90	250	1682	7.41	169	344
<b>W 75 - 10</b>	10	67	88	175	2036	6.42	169	504
<b>W 75 - 15</b>	15	60	85	117	2213	4.82	169	645
<b>W 75 - 20</b>	20	56	83	88	2213	3.70	169	767
<b>W 75 - 25</b>	25	52	80	70	2213	3.07	169	863
<b>W 75 - 30</b>	30	45	77	58	2390	2.87	169	919
<b>W 75 - 40</b>	40	40	72	44	2257	2.18	169	1072
<b>W 75 - 50</b>	50	36	68	35	1947	1.59	169	1216
<b>W 75 - 60</b>	60	33	65	29	1770	1.26	169	1340
<b>W 75 - 80</b>	80	28	59	22	1593	0.94	169	1394
<b>W 75 - 100</b>	100	25	55	18	1328	0.67	169	1394

## WR 75

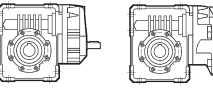
**2832 lb·in**

	$n_1 = 1750$ rpm (4 pole motor)							
	<b>i</b> (ratio)	$\eta_s$ (%)	$\eta_d$ (%)	$n_2$ [rpm]	$T_{n2}$ [lb·in]	$P_{n1}$ [hp]	$R_{n1}$ [lb]	$R_{n2}$ [lb]
<b>WR 75 - 21</b>	21	70	86	83.3	1991	3.06	112	688
<b>WR 75 - 30</b>	30	66	84	58.3	2434	2.68	112	812
<b>WR 75 - 45</b>	45	59	80	38.9	2611	2.01	112	1018
<b>WR 75 - 60</b>	60	55	77	29.2	2611	1.57	112	1187
<b>WR 75 - 75</b>	75	51	73	23.3	2611	1.32	112	1324
<b>WR 75 - 90</b>	90	44	69	19.4	2832	1.27	112	1394
<b>WR 75 - 120</b>	120	39	63	14.6	2699	0.99	112	1394
<b>WR 75 - 150</b>	150	35	58	11.7	2301	0.73	112	1394
<b>WR 75 - 180</b>	180	32	55	9.7	2080	0.58	112	1394
<b>WR 75 - 240</b>	240	27	49	7.3	1903	0.45	112	1394
<b>WR 75 - 300</b>	300	24	44	5.8	1593	0.34	112	1394

## VF/W 44/75

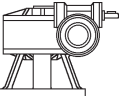
**3275 lb·in**

	$n_1 = 1750$ rpm (4 pole motor)							
	<b>i</b> (ratio)	$\eta_s$ (%)	$\eta_d$ (%)	$n_2$ [rpm]	$T_{n2}$ [lb·in]	$P_{n1}$ [hp]	$R_{n1}$ [lb]	$R_{n2}$ [lb]
<b>VF/W 44/75 - 250</b>	250	34	57	7.0	3275	0.64	49	1048
<b>VF/W 44/75 - 300</b>	300	30	51	5.8	3275	0.59	49	1160
<b>VF/W 44/75 - 400</b>	400	26	46	4.4	3275	0.49	49	1394
<b>VF/W 44/75 - 525</b>	525	25	44	3.3	3275	0.39	49	1394
<b>VF/W 44/75 - 700</b>	700	24	42	2.5	3275	0.31	49	1394
<b>VF/W 44/75 - 920</b>	920	21	40	1.9	3275	0.25	—	1394
<b>VF/W 44/75 - 1200</b>	1200	18	37	1.5	3275	0.20	—	1394
<b>VF/W 44/75 - 1500</b>	1500	17	37	1.2	3275	0.16	49	1394
<b>VF/W 44/75 - 2100</b>	2100	14	30	0.8	3275	0.14	49	1394
<b>VF/W 44/75 - 2800</b>	2800	12	26	0.6	3275	0.12	49	1394

Dynamic efficiency included in output values

**W 86**

**3275 lb·in**

$n_1 = 1750$  rpm (4 pole motor)

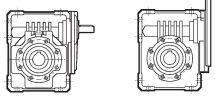

	<b>i</b> (ratio)	$\eta_s$ (%)	$\eta_d$ (%)	<b>n<sub>2</sub></b> [rpm]	<b>T<sub>n2</sub></b> [lb·in]	<b>P<sub>n1</sub></b> [hp]	<b>R<sub>n1</sub></b> [lb]	<b>R<sub>n2</sub></b> [lb]
<b>W 86 – 7</b>	7	71	89	250	2213	9.86	191	881
<b>W 86 – 10</b>	10	67	88	175	2567	8.10	191	1039
<b>W 86 – 15</b>	15	60	85	117	2921	6.36	191	1239
<b>W 86 – 20</b>	20	60	84	88	2832	4.68	191	1434
<b>W 86 – 23</b>	23	58	82	76	2832	4.17	191	1529
<b>W 86 – 30</b>	30	45	76	58	3275	3.99	191	1574
<b>W 86 – 40</b>	40	45	75	44	2921	2.70	191	1574
<b>W 86 – 46</b>	46	43	73	38	3009	2.49	191	1574
<b>W 86 – 56</b>	56	39	70	31	2655	1.88	191	1574
<b>W 86 – 64</b>	64	37	68	27	2478	1.58	191	1574
<b>W 86 – 80</b>	80	33	64	22	2257	1.22	191	1574
<b>W 86 – 100</b>	100	29	59	18	2036	0.96	191	1574

**WR 86**

**3894 lb·in**

$n_1 = 1750$  rpm (4 pole motor)

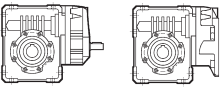

	<b>i</b> (ratio)	$\eta_s$ (%)	$\eta_d$ (%)	<b>n<sub>2</sub></b> [rpm]	<b>T<sub>n2</sub></b> [lb·in]	<b>P<sub>n1</sub></b> [hp]	<b>R<sub>n1</sub></b> [lb]	<b>R<sub>n2</sub></b> [lb]
<b>WR 86 – 21</b>	21	70	85	83.3	2611	4.06	112	1365
<b>WR 86 – 30</b>	30	66	82	58.3	3053	3.45	112	1574
<b>WR 86 – 45</b>	45	59	78	38.9	3452	2.73	112	1574
<b>WR 86 – 60</b>	60	59	77	29.2	3363	2.02	112	1574
<b>WR 86 – 69</b>	69	57	75	25.4	3363	1.80	112	1574
<b>WR 86 – 90</b>	90	44	67	19.4	3894	1.79	112	1574
<b>WR 86 – 120</b>	120	44	66	14.6	3452	1.21	112	1574
<b>WR 86 – 138</b>	138	42	63	12.7	3584	1.14	112	1574
<b>WR 86 – 168</b>	168	38	60	10.4	3142	0.87	112	1574
<b>WR 86 – 192</b>	192	36	58	9.1	2921	0.73	112	1574
<b>WR 86 – 240</b>	240	32	53	7.3	2699	0.59	112	1574
<b>WR 86 – 300</b>	300	28	49	5.8	2434	0.46	112	1574

**VF/W 44/86**

**4425 lb·in**

$n_1 = 1750$  rpm (4 pole motor)

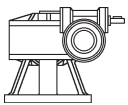

	<b>i</b> (ratio)	$\eta_s$ (%)	$\eta_d$ (%)	<b>n<sub>2</sub></b> [rpm]	<b>T<sub>n2</sub></b> [lb·in]	<b>P<sub>n1</sub></b> [hp]	<b>R<sub>n1</sub></b> [lb]	<b>R<sub>n2</sub></b> [lb]
<b>VF/W 44/86 – 230</b>	230	38	54	7.6	4425	0.99	49	1574
<b>VF/W 44/86 – 300</b>	300	30	45	5.8	4425	0.91	49	1574
<b>VF/W 44/86 – 400</b>	400	30	41	4.4	4425	0.75	49	1574
<b>VF/W 44/86 – 525</b>	525	25	42	3.3	4425	0.56	49	1574
<b>VF/W 44/86 – 700</b>	700	25	39	2.5	4425	0.45	49	1574
<b>VF/W 44/86 – 920</b>	920	22	40	1.9	4425	0.33	49	1574
<b>VF/W 44/86 – 1380</b>	1380	17	32	1.3	4425	0.28	49	1574
<b>VF/W 44/86 – 1840</b>	1840	17	30	1.0	4425	0.22	49	1574
<b>VF/W 44/86 – 2116</b>	2116	16	28	0.8	4425	0.21	49	1574
<b>VF/W 44/86 – 2760</b>	2760	14	24	0.6	4425	0.19	—	1574



## W 110

**6195 lb-in**

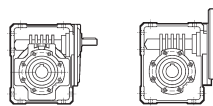
	$n_1 = 1750$ rpm (4 pole motor)							
	i (ratio)	$\eta_s$ (%)	$\eta_d$ (%)	$n_2$ [rpm]	$T_{n2}$ [lb-in]	$P_{n1}$ [hp]	$R_{n1}$ [lb]	$R_{n2}$ [lb]
<b>W 110 – 7</b>	7	71	89	250	4425	19.72	270	1128
<b>W 110 – 10</b>	10	67	87	175	4868	15.54	270	1392
<b>W 110 – 15</b>	15	60	84	117	5310	11.70	270	1706
<b>W 110 – 20</b>	20	61	84	88	5045	8.34	270	1798
<b>W 110 – 23</b>	23	59	83	76	4779	6.95	270	1798
<b>W 110 – 30</b>	30	45	77	58	6195	7.45	270	1798
<b>W 110 – 40</b>	40	46	76	44	5930	5.42	270	1798
<b>W 110 – 46</b>	46	44	74	38	5310	4.33	270	1798
<b>W 110 – 56</b>	56	41	72	31	5310	3.66	270	1798
<b>W 110 – 64</b>	64	38	70	27	4691	2.91	270	1798
<b>W 110 – 80</b>	80	34	66	22	4160	2.19	270	1798
<b>W 110 – 100</b>	100	30	62	18	4071	1.82	270	1798

## WR 110

**7346 lb-in**

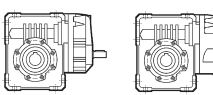
	$n_1 = 1750$ rpm (4 pole motor)							
	i (ratio)	$\eta_s$ (%)	$\eta_d$ (%)	$n_2$ [rpm]	$T_{n2}$ [lb-in]	$P_{n1}$ [hp]	$R_{n1}$ [lb]	$R_{n2}$ [lb]
<b>WR 110 – 21</b>	21	70	86	83.3	5266	8.10	157	1787
<b>WR 110 – 30</b>	30	66	84	58.3	5797	6.39	157	1798
<b>WR 110 – 45</b>	45	59	80	38.9	6284	4.85	157	1798
<b>WR 110 – 60</b>	60	60	79	29.2	5974	3.50	157	1798
<b>WR 110 – 69</b>	69	58	77	25.4	5664	2.96	157	1798
<b>WR 110 – 90</b>	90	44	70	19.4	7346	3.24	157	1798
<b>WR 110 – 120</b>	120	45	68	14.6	7036	2.39	157	1798
<b>WR 110 – 138</b>	138	43	66	12.7	6284	1.92	157	1798
<b>WR 110 – 168</b>	168	40	63	10.4	6284	1.65	157	1798
<b>WR 110 – 192</b>	192	37	60	9.1	5576	1.34	157	1798
<b>WR 110 – 240</b>	240	33	56	7.3	4956	1.02	157	1798
<b>WR 110 – 300</b>	300	29	51	5.8	4823	0.88	157	1798

## VF/W 49/110

**8850 lb-in**

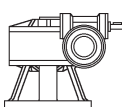
	$n_1 = 1750$ rpm (4 pole motor)							
	i (ratio)	$\eta_s$ (%)	$\eta_d$ (%)	$n_2$ [rpm]	$T_{n2}$ [lb-in]	$P_{n1}$ [hp]	$R_{n1}$ [lb]	$R_{n2}$ [lb]
<b>VF/W 49/110 – 230</b>	230	38	52	7.6	8850	2.05	90	1798
<b>VF/W 49/110 – 300</b>	300	29	48	5.8	8850	1.71	90	1798
<b>VF/W 49/110 – 400</b>	400	30	45	4.4	8850	1.37	90	1798
<b>VF/W 49/110 – 540</b>	540	25	41	3.2	8850	1.11	90	1798
<b>VF/W 49/110 – 720</b>	720	24	40	2.4	8850	0.85	90	1798
<b>VF/W 49/110 – 1080</b>	1080	18	31	1.6	8850	0.73	90	1798
<b>VF/W 49/110 – 1350</b>	1350	16	30	1.3	8850	0.61	90	1798
<b>VF/W 49/110 – 1656</b>	1656	17	30	1.1	8850	0.49	90	1798
<b>VF/W 49/110 – 2070</b>	2070	15	28	0.8	8850	0.42	90	1798
<b>VF/W 49/110 – 2800</b>	2800	13	24	0.6	8850	0.37	90	1798

Dynamic efficiency included in output values

## VF 130

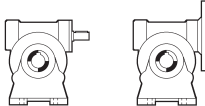
**9793 lb-in**

	$n_1 = 1750$ rpm (4 pole motor)							
	<b>i</b> (ratio)	$\eta_s$ (%)	$\eta_d$ (%)	$n_2$ [rpm]	$T_{n2}$ [lb-in]	$P_{n1}$ [hp]	$R_{n1}$ [lb]	$R_{n2}$ [lb]
<b>VF 130 – 7</b>	7	71	89	250	6549	29.19	337	1347
<b>VF 130 – 10</b>	10	67	88	175	6992	22.06	337	1713
<b>VF 130 – 15</b>	15	63	86	117	8142	17.53	337	2046
<b>VF 130 – 20</b>	20	59	84	88	7965	13.16	337	2412
<b>VF 130 – 23</b>	23	57	83	76	7877	11.46	337	2594
<b>VF 130 – 30</b>	30	49	79	58	9293	10.89	—	2814
<b>VF 130 – 40</b>	40	44	76	44	9735	8.89	—	2832
<b>VF 130 – 46</b>	46	45	76	38	9293	7.38	—	2832
<b>VF 130 – 56</b>	56	42	73	31	8496	5.77	211	2832
<b>VF 130 – 64</b>	64	39	71	27	8231	5.03	274	2832
<b>VF 130 – 80</b>	80	35	68	22	7788	3.98	337	2832
<b>VF 130 – 100</b>	100	31	64	18	6903	2.99	337	2832

## VFR 130

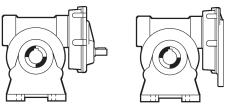
**13275 lb-in**

	$n_1 = 1750$ rpm (4 pole motor)							
	<b>i</b> (ratio)	$\eta_s$ (%)	$\eta_d$ (%)	$n_2$ [rpm]	$T_{n2}$ [lb-in]	$P_{n1}$ [hp]	$R_{n1}$ [lb]	$R_{n2}$ [lb]
<b>VFR 130 – 60</b>	60	58	78	29.2	11948	7.09	225	3102
<b>VFR 130 – 69</b>	69	56	76	25.4	11505	6.09	225	3102
<b>VFR 130 – 90</b>	90	48	71	19.4	13275	5.77	225	3102
<b>VFR 130 – 120</b>	120	43	67	14.6	12390	4.28	225	3102
<b>VFR 130 – 138</b>	138	44	67	12.7	11948	3.59	225	3102
<b>VFR 130 – 168</b>	168	41	64	10.4	10620	2.74	225	3102
<b>VFR 130 – 192</b>	192	38	61	9.1	10620	2.52	225	3102
<b>VFR 130 – 240</b>	240	34	57	7.3	10178	2.07	225	3102
<b>VFR 130 – 300</b>	300	30	53	5.8	7965	1.39	225	3102

## W/VF 63/130

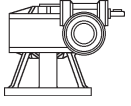
**15930 lb-in**

	$n_1 = 1750$ rpm (4 pole motor)							
	<b>i</b> (ratio)	$\eta_s$ (%)	$\eta_d$ (%)	$n_2$ [rpm]	$T_{n2}$ [lb-in]	$P_{n1}$ [hp]	$R_{n1}$ [lb]	$R_{n2}$ [lb]
<b>W/VF 63/130 – 280</b>	280	31	50	6.3	15930	3.16	108	3102
<b>W/VF 63/130 – 400</b>	400	29	44	4.4	15930	2.51	108	3102
<b>W/VF 63/130 – 600</b>	600	26	40	2.9	15930	1.84	108	3102
<b>W/VF 63/130 – 760</b>	760	24	39	2.3	15930	1.49	108	3102
<b>W/VF 63/130 – 960</b>	960	23	37	1.8	15930	1.25	108	3102
<b>W/VF 63/130 – 1200</b>	1200	19	34	1.5	15930	1.08	—	3102
<b>W/VF 63/130 – 1520</b>	1520	18	32	1.2	15930	0.91	—	3102
<b>W/VF 63/130 – 1800</b>	1800	16	28	1.0	15930	0.88	—	3102
<b>W/VF 63/130 – 2560</b>	2560	14	23	0.7	15930	0.75	—	3102
<b>W/VF 63/130 – 3200</b>	3200	12	17	0.5	15930	0.81	—	3102

Dynamic efficiency included in output values

## VF 150

**13718 lb·in**

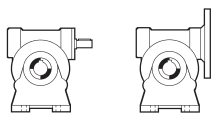
	$n_1 = 1750$ rpm (4 pole motor)							
	<b>i</b> (ratio)	$\eta_s$ (%)	$\eta_d$ (%)	$n_2$ [rpm]	$T_{n2}$ [lb·in]	$P_{n1}$ [hp]	$R_{n1}$ [lb]	$R_{n2}$ [lb]
<b>VF 150 – 7</b>	7	72	90	250	8850	39.01	495	1358
<b>VF 150 – 10</b>	10	68	88	175	9293	29.32	495	1825
<b>VF 150 – 15</b>	15	64	87	117	10178	21.65	495	2246
<b>VF 150 – 20</b>	20	59	84	88	11505	19.02	495	2542
<b>VF 150 – 23</b>	23	57	83	76	11240	16.35	495	2763
<b>VF 150 – 30</b>	30	48	80	58	12125	14.03	495	3087
<b>VF 150 – 40</b>	40	44	77	44	13629	12.29	187	3305
<b>VF 150 – 46</b>	46	45	77	38	13718	10.75	315	3305
<b>VF 150 – 56</b>	56	42	74	31	12125	8.12	495	3305
<b>VF 150 – 64</b>	64	39	72	27	11771	7.09	495	3305
<b>VF 150 – 80</b>	80	35	69	22	11063	5.56	495	3305
<b>VF 150 – 100</b>	100	31	65	18	10178	4.35	495	3305

## VFR 150

**17258 lb·in**

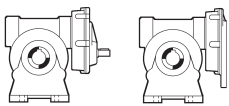
	$n_1 = 1750$ rpm (4 pole motor)							
	<b>i</b> (ratio)	$\eta_s$ (%)	$\eta_d$ (%)	$n_2$ [rpm]	$T_{n2}$ [lb·in]	$P_{n1}$ [hp]	$R_{n1}$ [lb]	$R_{n2}$ [lb]
<b>VFR 150 – 45</b>	45	63	82	38.9	15045	11.32	337	3278
<b>VFR 150 – 60</b>	60	58	79	29.2	16815	9.85	337	3597
<b>VFR 150 – 69</b>	69	56	77	25.4	16373	8.56	337	3597
<b>VFR 150 – 90</b>	90	47	72	19.4	17258	7.39	337	3597
<b>VFR 150 – 120</b>	120	43	68	14.6	17700	6.02	337	3597
<b>VFR 150 – 138</b>	138	44	68	12.7	17700	5.24	337	3597
<b>VFR 150 – 168</b>	168	41	65	10.4	15488	3.94	337	3597
<b>VFR 150 – 192</b>	192	38	62	9.1	15045	3.51	337	3597
<b>VFR 150 – 240</b>	240	34	58	7.3	13718	2.74	337	3597
<b>VFR 150 – 300</b>	300	30	54	5.8	11505	1.97	337	3597

## W/VF 86/150

**23010 lb·in**

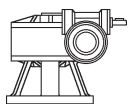
	$n_1 = 1750$ rpm (4 pole motor)							
	<b>i</b> (ratio)	$\eta_s$ (%)	$\eta_d$ (%)	$n_2$ [rpm]	$T_{n2}$ [lb·in]	$P_{n1}$ [hp]	$R_{n1}$ [lb]	$R_{n2}$ [lb]
<b>W/VF 86/150 – 200</b>	200	29	64	8.8	23010	4.99	191	3597
<b>W/VF 86/150 – 225</b>	225	26	63	7.8	23010	4.51	191	3597
<b>W/VF 86/150 – 300</b>	300	26	58	5.8	23010	3.67	191	3597
<b>W/VF 86/150 – 345</b>	345	26	58	5.1	23010	3.19	191	3597
<b>W/VF 86/150 – 460</b>	460	26	55	3.8	23010	2.53	191	3597
<b>W/VF 86/150 – 529</b>	529	26	55	3.3	23010	2.20	191	3597
<b>W/VF 86/150 – 690</b>	690	26	50	2.5	23010	1.85	191	3597
<b>W/VF 86/150 – 920</b>	920	26	45	1.9	23010	1.54	191	3597
<b>W/VF 86/150 – 1380</b>	1380	19	42	1.3	23010	1.10	191	3597
<b>W/VF 86/150 – 1840</b>	1840	19	38	1.0	23010	0.91	191	3597
<b>W/VF 86/150 – 2944</b>	2944	16	27	0.6	23010	0.80	191	3597

Dynamic efficiency included in output values

## VF 185

23276 lb·in

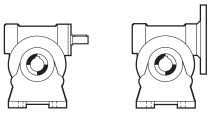
	$n_1 = 1750 \text{ rpm (4 pole motor)}$							
	i (ratio)	$\eta_s$ (%)	$\eta_d$ (%)	$n_2$ [rpm]	$T_{n2}$ [lb·in]	$P_{n1}$ [hp]	$R_{n1}$ [lb]	$R_{n2}$ [lb]
VF 185 – 7	7	72	90	250	15488	68.26	629	1252
VF 185 – 10	10	68	89	175	16107	50.25	629	2014
VF 185 – 15	15	66	88	117	16373	34.44	629	2608
VF 185 – 20	20	59	85	88	20090	32.81	629	2904
VF 185 – 30	30	54	83	58	17523	19.54	629	3808
VF 185 – 40	40	44	78	44	23276	20.71	—	4028
VF 185 – 50	50	41	76	35	22125	16.17	—	4046
VF 185 – 60	60	39	74	29	20090	12.56	173	4046
VF 185 – 80	80	33	69	22	18762	9.44	256	4046
VF 185 – 100	100	30	65	18	16815	7.18	629	4046

## VFR 185

31860 lb·in

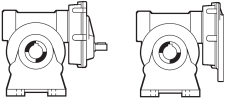
	$n_1 = 1750 \text{ rpm (4 pole motor)}$							
	i (ratio)	$\eta_s$ (%)	$\eta_d$ (%)	$n_2$ [rpm]	$T_{n2}$ [lb·in]	$P_{n1}$ [hp]	$R_{n1}$ [lb]	$R_{n2}$ [lb]
VFR 185 – 90	53	70	76	33.0	24780	17.08	382	4384
VFR 185 – 120	43	66	70	40.7	31860	29.39	382	4384
VFR 185 – 150	40	59	67	43.8	29205	30.26	382	4384
VFR 185 – 180	38	60	65	46.1	26550	29.85	382	4384
VFR 185 – 240	32	58	59	54.7	24780	36.44	382	4384
VFR 185 – 300	29	44	55	60.3	20355	35.44	382	4384

## W/VF 86/185

37170 lb·in

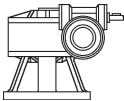
	$n_1 = 1750 \text{ rpm (4 pole motor)}$							
	i (ratio)	$\eta_s$ (%)	$\eta_d$ (%)	$n_2$ [rpm]	$T_{n2}$ [lb·in]	$P_{n1}$ [hp]	$R_{n1}$ [lb]	$R_{n2}$ [lb]
W/VF 86/185 – 280	280	31	52	6.3	37170	7.09	191	4384
W/VF 86/185 – 400	400	29	48	4.4	37170	5.38	191	4384
W/VF 86/185 – 600	600	26	45	2.9	37170	3.82	191	4384
W/VF 86/185 – 800	800	26	43	2.2	37170	3.00	191	4384
W/VF 86/185 – 920	920	26	42	1.9	37170	2.67	191	4384
W/VF 86/185 – 1200	1200	20	34	1.5	37170	2.53	191	4384
W/VF 86/185 – 1600	1600	20	35	1.1	37170	1.84	191	4384
W/VF 86/185 – 1840	1840	19	34	1.0	37170	1.65	191	4384
W/VF 86/185 – 2560	2560	16	29	0.7	37170	1.39	191	4384
W/VF 86/185 – 3200	3200	15	24	0.5	37170	1.34	191	4384

Dynamic efficiency included in output values

## VF 210

**30975 lb·in**

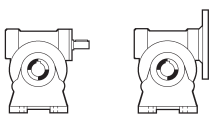
	$n_1 = 1750$ rpm (4 pole motor)							
	<b>i</b> (ratio)	$\eta_s$ (%)	$\eta_d$ (%)	<b>n<sub>2</sub></b> [rpm]	<b>T<sub>n2</sub></b> [lb·in]	<b>P<sub>n1</sub></b> [hp]	<b>R<sub>n1</sub></b> [lb]	<b>R<sub>n2</sub></b> [lb]
<b>VF 210 – 7</b>	7	71	90	250	20355	89.71	1191	3743
<b>VF 210 – 10</b>	10	69	89	175	23453	73.17	1191	4379
<b>VF 210 – 15</b>	15	63	88	117	25223	53.06	1191	5328
<b>VF 210 – 20</b>	20	57	85	88	27435	44.81	247	5989
<b>VF 210 – 30</b>	30	51	83	58	26993	30.10	396	7081
<b>VF 210 – 40</b>	40	42	78	44	30975	27.57	—	7081
<b>VF 210 – 50</b>	50	39	76	35	29205	21.34	—	7081
<b>VF 210 – 60</b>	60	36	73	29	26683	16.92	—	7081
<b>VF 210 – 80</b>	80	31	69	22	25665	12.91	—	7081
<b>VF 210 – 100</b>	100	27	65	18	23895	10.21	—	7081

## VFR 210

**44250 lb·in**

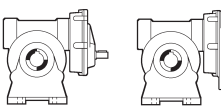
	$n_1 = 1750$ rpm (4 pole motor)							
	<b>i</b> (ratio)	$\eta_s$ (%)	$\eta_d$ (%)	<b>n<sub>2</sub></b> [rpm]	<b>T<sub>n2</sub></b> [lb·in]	<b>P<sub>n1</sub></b> [hp]	<b>R<sub>n1</sub></b> [lb]	<b>R<sub>n2</sub></b> [lb]
<b>VFR 210 – 30</b>	30	68	86	58.3	33630	36.19	495	6162
<b>VFR 210 – 45</b>	45	62	83	38.9	36285	26.98	495	7457
<b>VFR 210 – 60</b>	60	56	80	29.2	41595	24.06	495	7756
<b>VFR 210 – 90</b>	90	50	76	19.4	35400	14.37	495	7756
<b>VFR 210 – 120</b>	120	41	70	14.6	44250	14.63	495	7756
<b>VFR 210 – 150</b>	150	38	67	11.7	39825	11.00	495	7756
<b>VFR 210 – 180</b>	180	35	64	9.7	38055	9.17	495	7756
<b>VFR 210 – 240</b>	240	30	59	7.3	34515	6.77	495	7756
<b>VFR 210 – 300</b>	300	26	55	5.8	30090	5.06	495	7756

## VF/VF 130/210

**55755 lb·in**

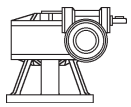
	$n_1 = 1750$ rpm (4 pole motor)							
	<b>i</b> (ratio)	$\eta_s$ (%)	$\eta_d$ (%)	<b>n<sub>2</sub></b> [rpm]	<b>T<sub>n2</sub></b> [lb·in]	<b>P<sub>n1</sub></b> [hp]	<b>R<sub>n1</sub></b> [lb]	<b>R<sub>n2</sub></b> [lb]
<b>VF/VF 130/210 – 280</b>	280	30	52	6.3	55755	10.63	337	7756
<b>VF/VF 130/210 – 400</b>	400	28	50	4.4	55755	7.74	337	7756
<b>VF/VF 130/210 – 600</b>	600	26	43	2.9	55755	6.00	337	7756
<b>VF/VF 130/210 – 800</b>	800	25	41	2.2	55755	4.72	337	7756
<b>VF/VF 130/210 – 920</b>	920	24	37	1.9	55755	4.55	337	7756
<b>VF/VF 130/210 – 1200</b>	1200	21	35	1.5	55755	3.69	—	7756
<b>VF/VF 130/210 – 1600</b>	1600	18	32	1.1	55755	3.02	—	7756
<b>VF/VF 130/210 – 1840</b>	1840	19	30	1.0	55755	2.80	—	7756
<b>VF/VF 130/210 – 2560</b>	2560	16	24	0.7	55755	2.52	274	7756
<b>VF/VF 130/210 – 3200</b>	3200	15	22	0.5	55755	2.20	337	7756

Dynamic efficiency included in output values

## VF 250

**42480 lb·in**

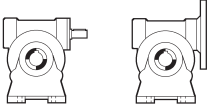
	$n_1 = 1750$ rpm (4 pole motor)							
	<b>i</b> (ratio)	$\eta_s$ (%)	$\eta_d$ (%)	<b>n<sub>2</sub></b> [rpm]	<b>T<sub>n2</sub></b> [lb·in]	<b>P<sub>n1</sub></b> [hp]	<b>R<sub>n1</sub></b> [lb]	<b>R<sub>n2</sub></b> [lb]
VF 250 – 7	7	71	91	250	28320	123.45	1574	4916
VF 250 – 10	10	69	90	175	32745	101.02	1574	5683
VF 250 – 15	15	64	88	117	35400	74.47	1574	6816
VF 250 – 20	20	59	86	88	39383	63.58	1574	7618
VF 250 – 30	30	53	84	58	35400	39.01	1574	9127
VF 250 – 40	40	41	79	44	42480	37.33	—	9900
VF 250 – 50	50	36	76	35	39825	29.10	—	10566
VF 250 – 60	60	38	76	29	39825	24.25	—	10566
VF 250 – 80	80	32	71	22	34515	16.87	—	10566
VF 250 – 100	100	29	68	18	32303	13.19	677	10566

## VFR 250

**62835 lb·in**

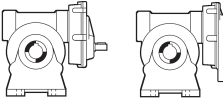
	$n_1 = 1750$ rpm (4 pole motor)							
	<b>i</b> (ratio)	$\eta_s$ (%)	$\eta_d$ (%)	<b>n<sub>2</sub></b> [rpm]	<b>T<sub>n2</sub></b> [lb·in]	<b>P<sub>n1</sub></b> [hp]	<b>R<sub>n1</sub></b> [lb]	<b>R<sub>n2</sub></b> [lb]
VFR 250 – 30	30	68	86	58.3	53100	57.15	787	7652
VFR 250 – 45	45	63	84	38.9	56640	41.61	787	9277
VFR 250 – 60	60	58	81	29.2	62835	35.90	787	10372
VFR 250 – 90	90	52	78	19.4	53100	21.00	787	11690
VFR 250 – 120	120	40	71	14.6	61950	20.19	787	11690
VFR 250 – 150	150	35	67	11.7	57525	15.89	787	11690
VFR 250 – 180	180	37	67	9.7	55755	12.84	787	11690
VFR 250 – 240	240	31	61	7.3	47790	9.06	787	11690
VFR 250 – 300	300	28	57	5.8	44250	7.19	787	11690

## VF/VF 130/250

**79650 lb·in**

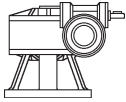
	$n_1 = 1750$ rpm (4 pole motor)							
	<b>i</b> (ratio)	$\eta_s$ (%)	$\eta_d$ (%)	<b>n<sub>2</sub></b> [rpm]	<b>T<sub>n2</sub></b> [lb·in]	<b>P<sub>n1</sub></b> [hp]	<b>R<sub>n1</sub></b> [lb]	<b>R<sub>n2</sub></b> [lb]
VF/VF 130/250 – 280	280	29	53	6.3	79650	14.90	337	11690
VF/VF 130/250 – 400	400	27	49	4.4	79650	11.28	337	11690
VF/VF 130/250 – 600	600	26	44	2.9	79650	8.38	337	11690
VF/VF 130/250 – 800	800	24	42	2.2	79650	6.58	337	11690
VF/VF 130/250 – 920	920	23	37	1.9	79650	6.50	337	11690
VF/VF 130/250 – 1200	1200	20	35	1.5	79650	5.27	—	11690
VF/VF 130/250 – 1600	1600	18	32	1.1	79650	4.32	—	11690
VF/VF 130/250 – 1840	1840	18	31	1.0	79650	3.88	—	11690
VF/VF 130/250 – 2560	2560	16	25	0.7	79650	3.46	337	11690
VF/VF 130/250 – 3200	3200	14	21	0.5	79650	3.29	337	11690

Dynamic efficiency included in output values

## Imperial Dimensioned Output Shafts for Worm Gear Reducers

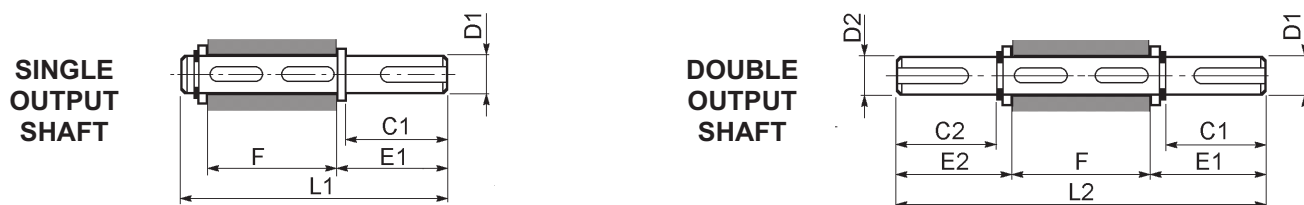

Model	C1	D1	E1	L1	C2	D2	E2	L2	F	KEY
VF 30	1.000	0.500	1.157	3.480	1.000	0.500	1.157	4.480	2.165	1/8
	25.40	12.70	29.40	88.40	25.40	12.70	29.40	113.80	55	3.175
VF 44	1.563	0.750	1.760	4.516	1.563	0.687	1.759	6.039	2.520	3/16
	39.70	19.05	44.70	114.70	39.70	17.46	44.69	153.39	64	4.763
VF 49	2.000	1.000	2.197	5.701	2.000	0.9375	2.235	7.779	3.228	1/4
	50.80	25.40	55.80	144.80	50.80	23.81	56.78	197.58	82	6.350
W 63	2.000	1.125	2.197	7.197	2.000	0.9375	2.106	9.157	4.724	1/4
	50.80	28.58	55.80	182.80	50.80	23.81	53.48	232.58	120	6.350
W 75	2.375	1.250	2.572	7.847	2.000	1.125	2.157	7.847	5.000	1/4
	60.33	31.75	65.32	199.32	50.80	28.58	54.80	199.32	127	6.350
W 86	2.375	1.375	2.572	8.438	2.375	1.375	2.533	10.774	5.512	5/16
	60.33	34.93	65.32	214.32	60.32	34.93	64.35	273.67	140	7.938
W 110	4.312	1.625	4.509	10.966	4.312	1.625	4.422	15.201	6.102	3/8
	109.53	41.28	114.53	278.53	109.53	41.28	112.32	386.10	155	9.525

## IEC Adaptor for Conversion to NEMA C

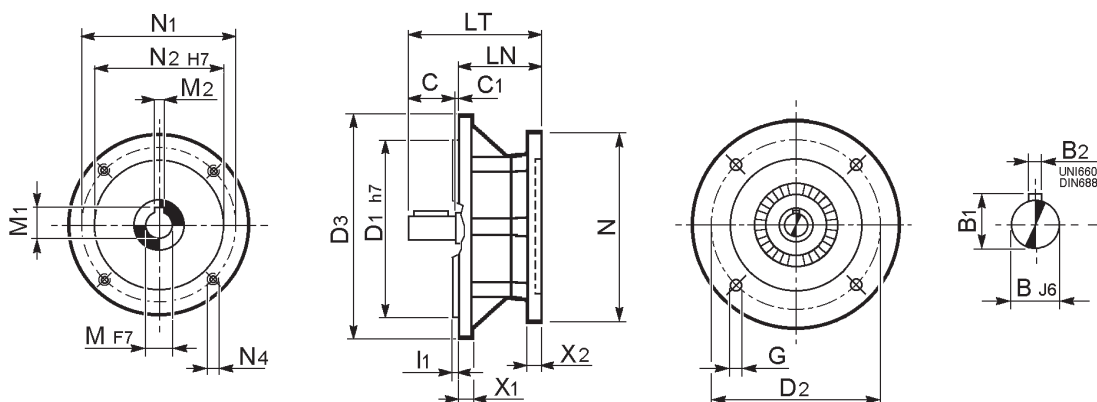

Motor	IEC	B	B1	B2	C	C1	D1	D2	D3	G	I1	LN	LT	N	N1	N2	N4	M	M1	M2	X1	X2
ENTN56 P63	63	11	12.5	4	23	-	95	115	140	8.5	3	58.5	81.5	165	149.225	114.3	10.5	15.875	17.958	4.826	7.5	12
ENTN56 P71	71	14	16	5	30	3	110	130	160	9	3.5	55.5	88.5	165	149.225	114.3	10.5	15.875	17.958	4.826	7	13
ENTN56 P80	80	19	21.5	6	40	3	130	165	200	11	3.5	56.5	99.5	165	149.225	114.3	10.5	15.875	17.958	4.826	7	12
ENTN143T P80	80	19	21.5	6	40	2.5	130	165	200	11	3.5	57.1	99.6	165	149.225	114.3	10.5	22.225	24.409	4.826	7	13
ENTN145T P90	90	24	27	8	50	2.5	130	165	200	11	3.5	57.1	109.6	165	149.225	114.3	10.5	22.225	24.409	4.826	7	13
ENTN182T P100	100	28	31	8	60	2.5	180	215	250	14	4	78	140.5	226	184.15	215.9	13.5	28.575	32.4	6.4	7	16
ENTN184T P112	112	28	31	8	60	2.5	180	215	250	14	4	78	140.5	226	184.15	215.9	13.5	28.575	32.4	6.4	7	16
ENTN213T P132	132	38	41	10	80	-1	230	265	300	13	4	96.5	175.5	226	184.15	215.9	13.5	34.925	38.4	7.976	14	21

Dimension are  $\frac{\text{inch}}{\text{mm}}$





## 3.0 BONFIGLIOLI ELECTRIC MOTORS

### 3.1 GENERAL INFORMATION

BONFIGLIOLI RIDUTTORI three-phase AC induction motors and brake motors are designed for continuous operation, IEC dimensional standard and comply electrically with all relevant standards including NEMA MG1.

They are supplied either integral (M type) to a BONFIGLIOLI gear unit or flanged design (BN type).

The motors also comply with national standards adapted to IEC 60034-1 as charted along side.

(C1)

Canada	CSA C22.2 N° 100
Great Britain	BS5000 / BS 4999
Germany	DIN VDE 0530
Australia	AS 1359
Belgium	NBNC 51 - 101
Norway	NEK – IEC 34
France	NF C 51
Austria	OEVE M 10
Switzerland	SEV 3009
Netherlands	NEN 3173
Sweden	SS 426 01 01

#### Abbreviations and units

Symb.	U.m.	Description
$\cos \varphi$	–	Power factor
$\eta$	–	Efficiency
$f_m$	–	Intermittence adjustment factor
$f_t$	–	Ambient temperature factor
$I$	–	Cyclic duration factor
$I_n$	[A]	Rated current
$I_s$	[A]	Locked rotor current
$J_c$	[lb·ft <sup>2</sup> ]	Load inertia
$J_m$	[lb·ft <sup>2</sup> ]	Motor inertia
$n$	[rpm]	Speed
$K_c$	–	Torque factor
$K_d$	–	Load factor
$K_i$	–	Inertia factor
$T_b$	[lb·in]	Brake torque
$T_n$	[lb·in]	Motor rated torque
$T_a$	[lb·in]	Mean starting torque
$T_k$	[lb·in]	Breakdown torque
$T_L$	[lb·in]	Load torque
$T_s$	[lb·in]	Locked rotor torque
$P_b$	[W]	Power absorbed by brake coil
$P_n$	[W]	Rated power output
$t_1$	[ms]	Brake release time
$t_{1s}$	[ms]	Shorter brake release time
$t_2$	[ms]	Brake reaction time
$t_{2c}$	[ms]	Faster reaction time
$t_a$	[°C/ °F]	Ambient temperature
$t_f$	[min]	Operating time at constant load
$t_r$	[min]	Rest time
$W$	[lb·ft]	Brake work between two successive adjustments
$W_{max}$	[lb·ft]	Max permissible brake work
$Z$	[1/h]	Permissible starts per hour
$Z_0$	[1/h]	Permissible starts per hour (unloaded, I=50%)

#### Conversion table for commonly used metric – imperial units

##### Length

1 in	=	25.40 mm	= 0.0254 m
1 ft	=	304.8 mm	= 0.3048 m
1 yd	=	914.4 mm	= 0.9144 m

##### Area

1 in <sup>2</sup>	=	645.16 mm <sup>2</sup>	= 0.645×10 <sup>-3</sup> m <sup>2</sup>
1 ft <sup>2</sup>	=	92.9×10 <sup>3</sup> mm <sup>2</sup>	= 92.9× 10 <sup>3</sup> m <sup>2</sup>
1 yd <sup>2</sup>	=	836×10 <sup>3</sup> mm <sup>2</sup>	= 0.8361 m <sup>2</sup>

##### Volume

1 in <sup>3</sup>	=	16.4×10 <sup>-3</sup> dm <sup>3</sup>	= 16.4×10 <sup>-6</sup> m <sup>3</sup>
1 ft <sup>3</sup>	=	28.32 dm <sup>3</sup>	= 28.3×10 <sup>-3</sup> m <sup>3</sup>

##### Force – Weight

1 lbm	=	2.2046 Kg
1 lbf	=	4.4482 N

##### Torque

1 lb in	=	0.1129 Nm
1 lb ft	=	1.3558 Nm

##### Power

1 hp	=	0.7457 kW
------	---	-----------

##### Moment of inertia

1 lb ft <sup>2</sup>	=	4.214×10 <sup>-2</sup>	Kg m <sup>2</sup>
1 lb in s <sup>2</sup>	=	1.12985×10 <sup>-1</sup>	Kg m <sup>2</sup>
1 lb ft s <sup>2</sup>	=	1.35582	Kg m <sup>2</sup>

##### Pressure – stress

1 lb/in <sup>2</sup>	=	6.89×10 <sup>-3</sup>	N/mm <sup>2</sup>
1 lb/ft <sup>2</sup>	=	47.88	N/m <sup>2</sup>

##### Temperature

$t$ [°F]	=	$\frac{5}{9} \times [t - 32]$	[°C]
$T$ [°C]	=	$\left( \frac{9}{5} \times T + 32 \right)$	[°F]

## 3.2 MOTOR ORDERING NUMBERS

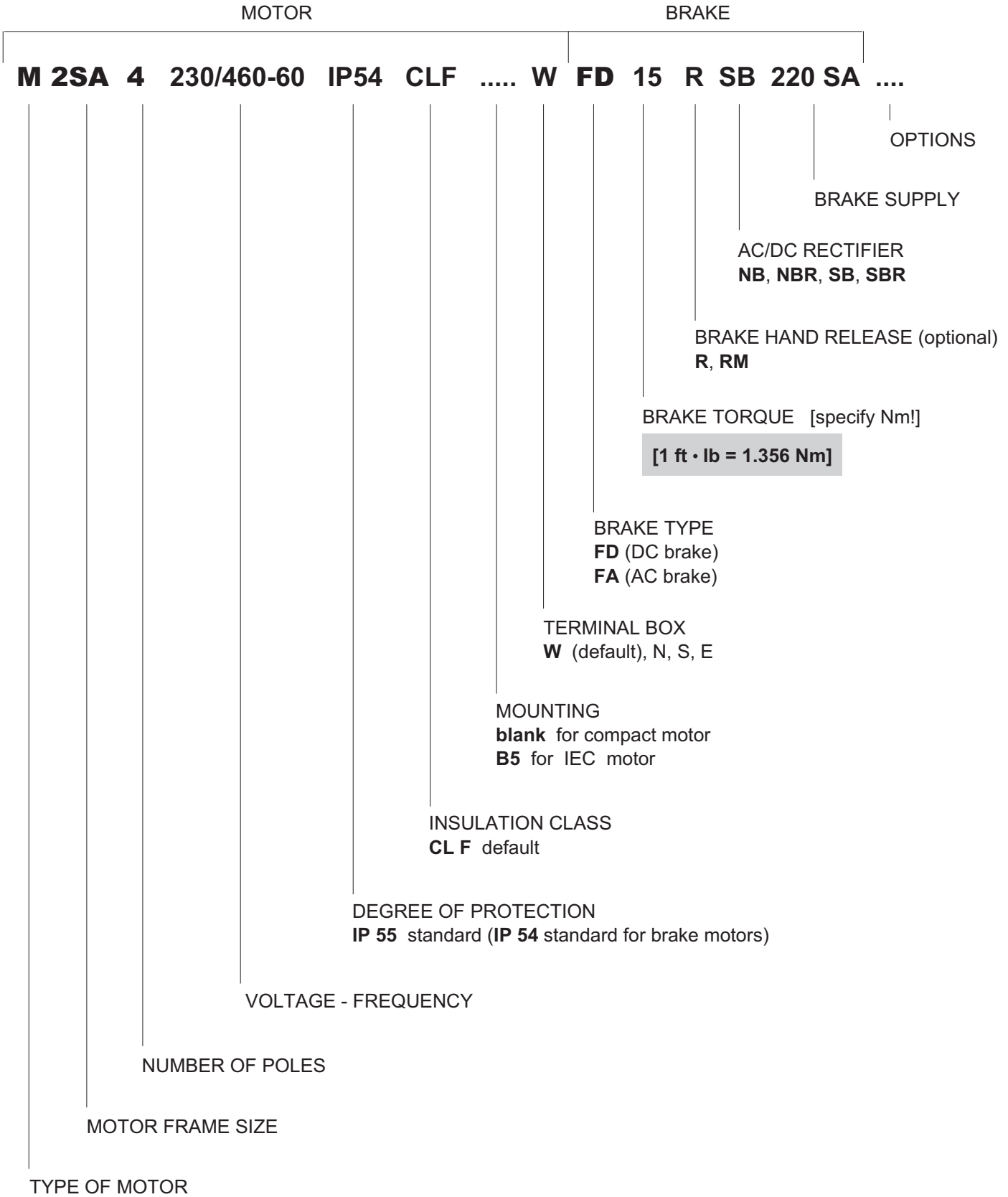

US power mains voltages and the corresponding rated voltages to be specified for the motor are indicated in the following table:

(C2)

Frequency	Mains voltage	V <sub>mot</sub>
60 Hz	208 V	<b>200 V</b>
	240 V	<b>230 V</b>
	480 V	<b>460 V</b>
	600 V	<b>575 V</b>

Motors with YY/Y connection (e.g. 230/460-60; 220/440-60) feature, as standard, a 9-stud terminal board.

For DC brake motors type BN\_FD, the rectifier is fed with 1-phase 230V a.c., factory pre-wired in the motor terminal box as standard.

**Brake power supply** for brake motors is as follows:

(C3)

<b>BN_FD M_FD</b>	
Wired to terminal box 1~230V a.c.	
<b>BN_FA M_FA</b>	
	Specify
Separate power supply 230V Δ - 60Hz	<b>230SA</b>
Separate power supply 460V Y - 60Hz	<b>460SA</b>

## Tolerances

As per the IEC standards applicable the tolerances here after apply to the following quantities.

(C4)

-0.15 (1 - η) P ≤ 75 hp	Efficiency
-(1 - cosφ)/6 min 0.02 max 0.07	Power factor
±20% *	Slip
+20%	Locked rotor current
-15% +25%	Locked rotor torque
-10%	Max. torque

\* ± 30% for motors with P<sub>n</sub> < 0.75 hp

## CUS

### Motors for USA and Canada

BN and M motors are available in NEMA Design C configuration (concerning electrical characteristics), certified to CSA (Canadian standard) C22.2 No. 100 and UL (Underwriters Laboratory) UL 1004. By specifying the option CUS the name plate is marked with both symbols shown here below.



## 3.3 MECHANICAL CHARACTERISTICS

### IP..

#### Enclosures

Motors are provided as totally enclosed fan-cooled (TEFC) according to NEMA MG1 1-26-2 1998 and they are designed for IP 55 (IP 54 for brake motors) degree of protection in accordance with NEMA MG1- 5 / IEC 60034-5 Standards. Higher degree of protection (IP 56, or IP 55 for brake motors) is available on request.

The following table provides an overview of the available degree of protection.

Regardless of the protection class specified on order, motors to be installed outdoors require protection against direct sunlight and in addition – when they are to be installed with the shaft downwards – a drip cover to keep out water and solid matter (option **RC**).

(C5)

		IP 54	IP 55	IP 56
		n.a.	standard	at request
<b>BN_FD BN_FA</b>	<b>M_FD M_FD</b>	standard	at request	n.a.

#### Cooling

The motors are self ventilated (IEC 411 / NEMA MG1-6) and are equipped with a plastic fan working in both directions. The motors must be installed allowing sufficient space between fan cowl and the nearest wall to ensure

free air intake and allow access for maintenance purposes on motor and brake, if supplied.

Independent, forced air ventilation (IEC 416 / NEMA MG1-6) can be supplied on request (option U1).

This solution enables to increase the motor duty factor when driven by an inverter and operating at reduced speed.

## Direction of rotation

Rotation is possible in both directions. If terminals U1, V1, and W1 are connected to line phases L1, L2 and L3, clockwise rotation (looking from drive end) is obtained. For counterclockwise rotation, switch two phases.

## Noise

Noise levels, measured using the method prescribed by ISO 1680 Standards, are within the maximum levels specified by Standards CEI EN 60034-9.

## Vibrations and balancing

Rotor shafts are balanced with half key fitted and fall within the vibration class N, as per Standard CEI EN 60034-14. If a further reduced noise level is required improved balancing can be optionally requested (class R). Table below shows the value for the vibration velocity for standard (N) and improved (R) balancing.

(C6)

Vibration class	Angular velocity n [rpm]	Limits of the vibration velocity [mm/s]	
		BN 56...BN 132 M05...M4	BN 160MR...BN 200 M5
<b>N</b>	600 ≤ n ≤ 3600	1.8	2.8
<b>R</b>	600 ≤ n ≤ 1800	0.71	1.12
	1800 < n ≤ 3600	1.12	1.8

Values refer to measures with freely suspended motor in unloaded conditions.

## Winding connection and motor terminal box

Standard terminal board has 9 studs for YY-Y dual-voltage winding and 6 studs for star/delta winding configuration (single-speed motors).



An earth terminal located in the terminal box is provided as standard on all motors.

For DC brake motors, the AC/DC rectifier is supplied in the terminal box and it is provided with adequately connected terminals.

All connections must be carried out according to the diagrams inside the terminal box or in the [instruction manual](#).

## Cable entry

(C7)

		Cable entry (metric thread)	Max cable diam. [mm]
<b>BN 63</b>	<b>M 05</b>	2 x M20	13
<b>BN 71</b>	<b>M 1</b>	2 x M25	17
<b>BN 80 - BN 90</b>	<b>M 2</b>	2 x M25	17
<b>BN 100</b>	<b>M 3</b>	2 x M32	21
		2 x M25	17
<b>BN 112</b>	-	2 x M32	17
		2 x M25	
<b>BN 132...BN 160MR</b>	<b>M 4</b>	4 x M32	21
<b>BN 160M...BN 200L</b>	<b>M 5</b>	2 x M40	29

## Bearings

Life lubricated preloaded radial ball bearings are used, types are shown in the chart here under.

Calculated endurance lifetime  $L_{10}$ , as per ISO 281, in unloaded condition, exceeds 40000 hrs.

**DE** = drive end

**NDE** = non drive end

(C8)

	<b>DE</b>		<b>NDE</b>	
	<b>M, M_FD, M_FA</b>	<b>M</b>	<b>M</b>	<b>M_FD, M_FA</b>
<b>M05</b>	6004 2Z C3	6201 2Z C3	6201 2RS C3	6201 2RS C3
<b>M1</b>	6004 2Z C3	6202 2Z C3	6202 2RS C3	6202 2RS C3
<b>M2</b>	6007 2Z C3	6204 2Z C3	6204 2RS C3	6204 2RS C3
<b>M3</b>	6207 2Z C3	6206 2Z C3	6206 2RS C3	6206 2RS C3
<b>M4</b>	6309 2Z C3	6208 2Z C3	6208 2RS C3	6208 2RS C3
<b>M5</b>	6309 2Z C3	6209 2Z C3	6209 2RS C3	6209 2RS C3

(C9)

	DE	NDE	
	BN, BN_FD, BN_FA	BN	BN_FD, BN_FA
<b>BN 56</b>	6201 2Z C3	6201 2Z C3	-
<b>BN 63</b>	6201 2Z C3	6201 2Z C3	6201 2Z C3
<b>BN 71</b>	6202 2Z C3	6202 2Z C3	6202 2Z C3
<b>BN 80</b>	6204 2Z C3	6204 2Z C3	6204 2Z C3
<b>BN 90</b>	6205 2Z C3	6205 2Z C3	6205 2Z C3
<b>BN 100</b>	6206 2Z C3	6206 2Z C3	6206 2Z C3
<b>BN 112</b>	6306 2Z C3	6306 2Z C3	6306 2Z C3
<b>BN 132</b>	6308 2Z C3	6308 2Z C3	6308 2Z C3
<b>BN 160MR</b>	6309 2Z C3	6309 2Z C3	6309 2Z C3
<b>BN 160M/L</b>	6309 2Z C3	6309 2Z C3	6309 2Z C3
<b>BN 180M</b>	6210 2Z C3	6309 2Z C3	6309 2Z C3
<b>BN 180L</b>	6310 2Z C3	6310 2Z C3	6310 2Z C3
<b>BN 200L</b>	6312 2Z C3	6310 2Z C3	6310 2Z C3

(C11)

Low Voltage	High Voltage
200V - 50Hz	346V - 50Hz
208V - 60Hz	360V - 60Hz
220V - 50Hz	380V - 50Hz
230V - 50Hz	400V - 50Hz
240V - 50Hz	415V - 50Hz
330V - 60Hz	575V - 60Hz

Single-Speed / Dual-Voltage	
<p>Low Voltage Δ</p> 	<p>High Voltage Y</p> 

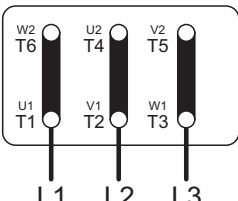
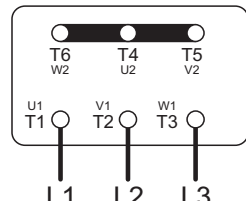
### 3.4 ELECTRICAL CHARACTERISTICS

#### Voltage

Motors can operate on any voltage within the range of 200 – 690 Volts. Voltage to be <600 V for CSA/UL motors. Voltage values available as standard are 230/460V-60 Hz and 575V-60Hz. Other voltage values may be available on request.

(C10)

Low Voltage	High Voltage
230V - 60Hz	460V - 60Hz
200V - 50Hz	400V - 50Hz

Single-Speed / Dual-Voltage	
<p>Low Voltage YY</p> 	<p>High Voltage Y</p> 

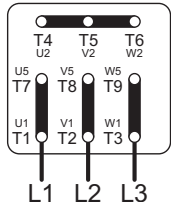
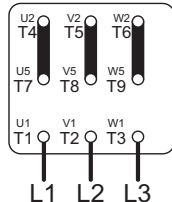
#### Rated horsepower

Motor outputs shown in this catalogue are based on continuous operation at 40 °C [100 °F] ambient temperature and maximum elevation not exceeding 3300 feet (1000 m) above the sea level.

Motors can operate at higher ambient temperatures with output adjusted in accordance with the chart (C12) here below.

(C12)

Ambient temperature [°F]	100	115	120	130	140
Power output as a % of rated power	100%	95%	90%	85%	80%

Should a derating factor higher than 15% apply, contact our Technical Service.

#### Insulation class

**CLF**

Bonfiglioli motors use class **F** insulating materials (enamelled wire, insulators, impregnation resins) as compared to the standard motor.

## CL H

Motors manufactured in higher insulation class **H** are available at request.

In standard motors, the stator windings temperature rise normally stays below the 80 K limit corresponding to class B over temperature.

A careful selection of insulating components makes the motors compatible with tropical climates and normal vibration.

For applications involving the presence of aggressive chemicals or high humidity, contact Bonfiglioli Engineering for assistance with product selection.

(C13)

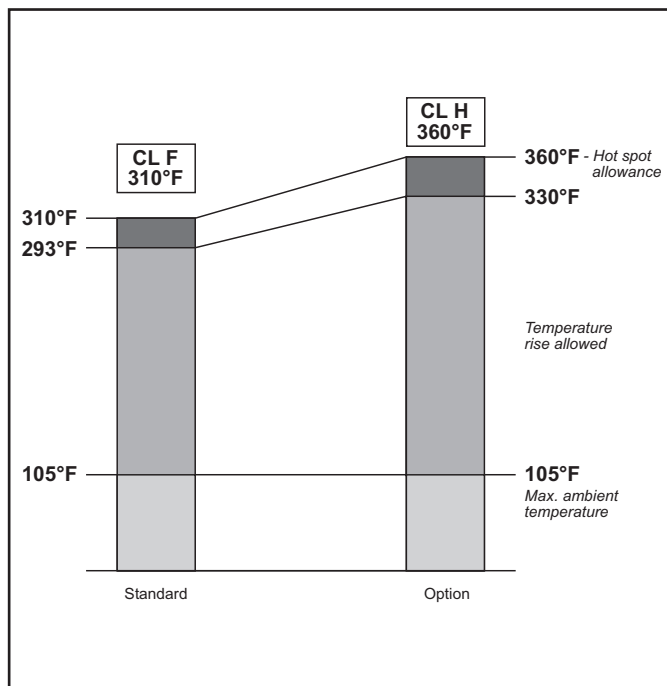

## Types of duty

Unless otherwise indicated, the power rating of motors specified in the catalogue refers to continuous duty S1. For motors used under conditions other than S1, the type of duty required is defined with reference to CEI EN 60034-1 Standards.

In particular, for intermittent duties type S2 and S3, power can be adjusted with respect to continuous duty through multipliers listed in table (C14) applicable to single speed motors.

$$f_m = \frac{P(S2...S8)}{P(S1)}$$

(C14)

	Duty						Consult factory	
	S2			S3 *				S4 - S8
	Cycle duration (min)			Cyclic duration factor (I)				
	10	30	60	25%	40%	60%		
$f_m$	1.35	1.15	1.05	1.25	1.15	1.1		

\* Cycle duration must, in any event, be equal to or less than 10 minutes; if this time is exceeded, please contact our Technical Service.

## Cycle duration factor:

$$I = \frac{t_f}{t_f + t_r} \times 100$$

$t_f$  = operating time at constant load

$t_r$  = rest time

## Limited duration duty S2

This type of duty is characterized by operation at constant load for a limited time, which is shorter than the time required to reach thermal equilibrium, followed by a rest period of sufficient duration to restore ambient temperature in the motor.

## Periodical intermittent duty S3

This type of duty is characterized by a sequence of identical operation cycles, each including a constant load operation period and a rest period.

For this type of duty, the starting current does not significantly influence overtemperature.

## Inverter-driven motors

The electric motors of series BN and M may be used in combination with PWM inverters with rated voltage at transformer input up to 500 V. Standard motors use a phase insulating system with separators, class 2 enam-

elled wire and class H impregnation resins (1600V peak-to-peak voltage pulse capacity and rise edge  $t_s > 0.1\mu s$  at motor terminals). Table (C15) shows the typical torque/speed curves referred to S1 duty for motors with base frequency  $f_b = 60$  Hz.

Because ventilation is somewhat impaired in operation at lower frequencies (approx. 30 Hz), standard motors with incorporated fan (IC411) require adequate torque derating or - alternately - the addition of a separate supply fan cooling.

Above base frequency, upon reaching the maximum output voltage of the inverter, the motor enters a steady-power field of operation, and shaft torque drops with ratio  $(f/f_b)$ .

As motor maximum torque decreases with  $(f/f_b)^2$ , the allowed overloading must be reduced progressively.

(C15)

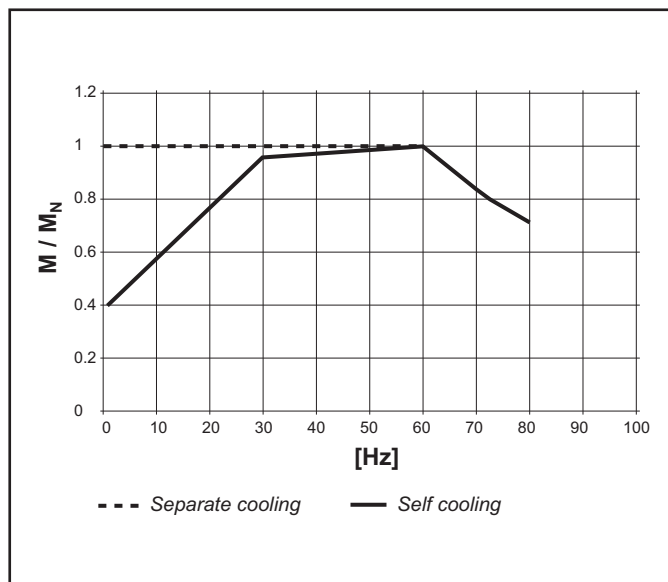



Table (C16) reports the mechanical limit speed for motor operation above rated frequency:

(C16)

		n [rpm]		
		2p	4p	6p
				
$\leq$ BN 112	M05...M3	5200	4000	3000
BN 132...BN 200L	M4, M5	4500	4000	3000

Above rated speed, motors generate increased mechanical vibration and fan noise. Class R rotor balancing is highly recommended in these applications. Installing a separate supply fan cooling may also be advisable.

Independent fan cooling and brake (if fitted) must always be connected direct to mains power supply.

## Permissible starts per hour

**Z**

The rating charts of brakemotors lend the permitted number of starts  $Z_0$ , based on 50% intermittence and for unloaded operation.

The catalogue value represents the maximum number of starts per hour for the motor without exceeding the rated temperature for the insulation class F.

To give a practical example for an application characterized by inertia  $J_c$ , drawing power  $P_r$  and requiring mean torque at start-up  $T_L$  the actual number of starts per hour for the motor can be calculated approximately through the following equation:

$$Z = \frac{Z_0 \times K_c \times K_d}{K_J}$$

where:

$$K_J = \frac{J_m + J_c}{J_m} = \text{inertia factor}$$

$$K_c = \frac{T_a - T_L}{T_a} = \text{torque factor}$$

$K_d$  = load factor (see table C16)

(C17)

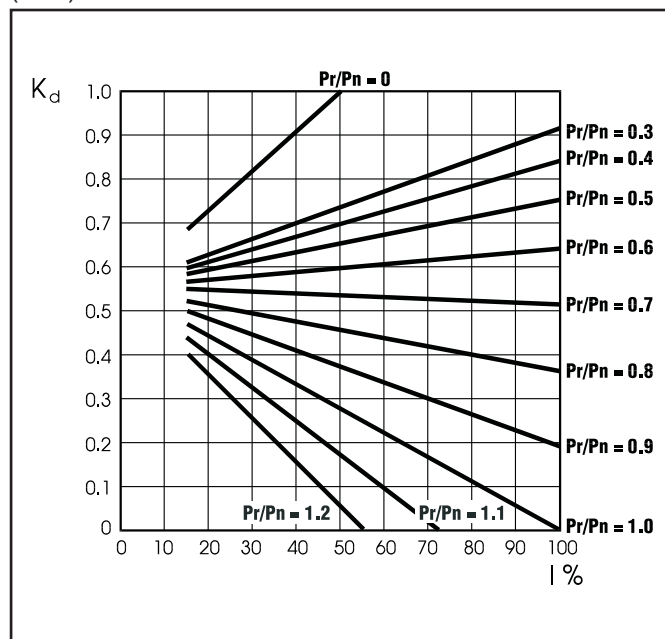

If actual starts per hour is within permitted value (Z) it may be worth checking that braking work is compatible with brake (thermal) capacity  $W_{max}$  also given in table (C22) and dependent on the number of switches (s/h).

## 3.5 BRAKE MOTORS

### Operation

Versions with incorporated brake use spring-applied DC (FD option) or AC (FA option) brakes.

All brakes are designed to provide fail-safe operation, meaning that they are applied by spring-action in the event of a power failure.

(C18)

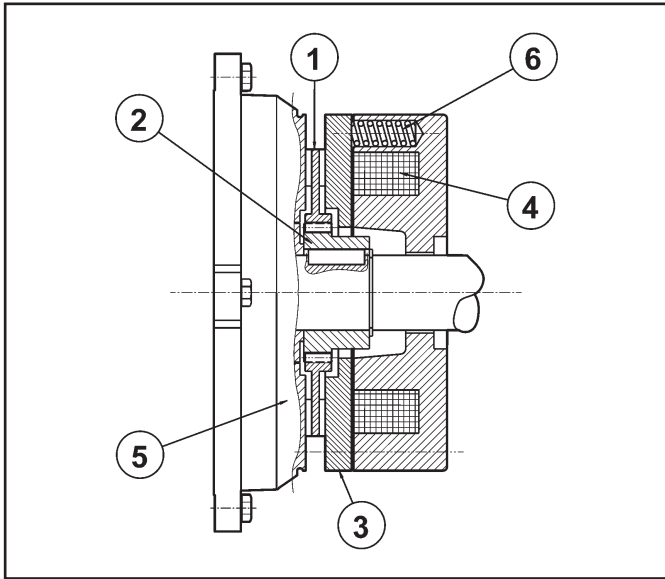

Key:

- ① brake disc
- ② disc carrier
- ③ pressure plate
- ④ brake coil
- ⑤ motor rear shield
- ⑥ brake springs

When power is disconnected, the springs push the armature plate against the brake disc. The disc becomes trapped between the armature plate and motor shield and stops the shaft from rotating.

When the coil is energized, a magnetic field attracts the

armature plate, so that the brake disc – which is integral with the motor shaft – is released.

### Most significant features

- High braking torques (normally  $T_b \approx 2 T_n$ ), braking torque adjustment.
- Steel brake disc with double friction lining (low-wear, asbestos-free lining).
- Hexagonal socket head on motor shaft end (N.D.E.) for manual rotation (not compatible with options PS, RC, TC, U1, U2, EN1, EN2, EN3).
- Manual release lever.
- Corrosion-proof treatment on all brake surfaces.
- Class F insulation



## 3.6 DC BRAKE MOTORS TYPE BN\_FD

Frame sizes: BN 63 ... BN 200L

(C19)

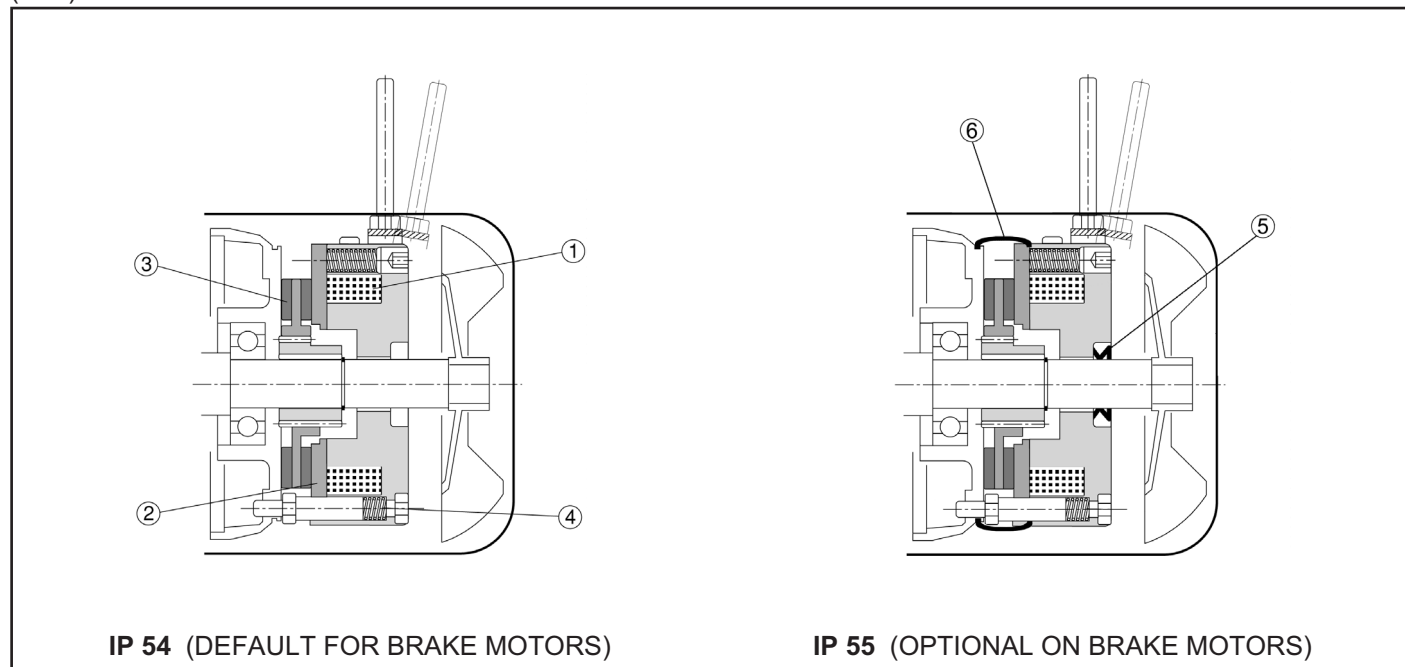

**Direct current** electromagnetic brake bolted onto motor shield. Preloading springs provide axial positioning of magnet body.

Brake disc slides axially on steel hub fitted onto motor shaft with anti-vibration spring.

Brake torque factory setting is indicated in the corresponding motor rating charts.

Braking torque may be modified by changing the type and/or number of springs.

At request, motors may be equipped with manual release lever with automatic return (**R**) or system for holding brake in the released position (**RM**).

See table (C33) for available release lever locations.

FD brakes ensure excellent dynamic performance with low noise. DC brake operating characteristics may be optimized to meet application requirements by choosing from the various rectifier/power supply and wiring connection options available.

### Protection class

Standard protection class is IP54.

Brake motor FD is also available in protection class **IP 55**, which incorporates the following variants:

- ① V-ring at N.D.E. of motor shaft
- ② dust and water-proof rubber boot
- ③ stainless steel shim placed between motor shield and brake disc
- ④ stainless steel hub
- ⑤ stainless steel brake disc

### FD brake power supply

A rectifier housed into the terminal box feeds the DC brake coil. Wiring connection across rectifier and brake coil is performed at the factory.

On single-speed motors, rectifier is pre-wired to the motor terminal board.

Rectifier standard power supply voltage  $V_B$  is as indicated in the following table (C20), regardless of mains frequency:

(C20)

<b>2, 4, 6 P</b>				<b>1 speed</b>	
	<b>BN_FD / M_FD</b>			brake connected to terminal board power supply	separate power supply
		$V_{mot} \pm 10\%$ 3 ~	$V_B \pm 10\%$ 1 ~		
<b>BN 63...BN 200</b>	<b>M05...M5</b>	230/460 V – 60 Hz	230 V	standard	specify <b>V<sub>B</sub> SA</b> or <b>V<sub>B</sub> SD</b>

The diode half-wave rectifier ( $V_{dc} \approx 0,45 \times V_{ac}$ ) is available in versions **NB**, **SB**, **NBR** e **SBR**, as detailed in the table (C21). Rectifier **SB** with electronic energizing control over-energizes the electromagnet upon power-up to cut brake release response time and then switches to normal half-wave operation once the brake has been released.

Use of the **SB** rectifier is mandatory in the event of:

- high number of operations per hour
- reduced brake release response time
- brake is exposed to extreme thermal stress

Rectifiers **NBR** or **SBR** are available for applications requiring quick brake release response.



These rectifiers complement the **NB** and **SB** types as their electronic circuit incorporates a static switch that de-energizes the brake quickly in the event voltage is missing.

This arrangement ensures short brake release response time with no need for additional external wiring and contacts.

Optimum performance of rectifiers **NBR** and **SBR** is achieved with separate brake power supply.

Available voltages: 230V ± 10%.

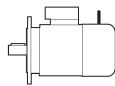
(C21)

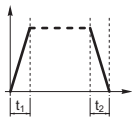
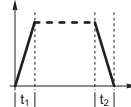
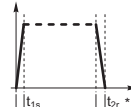
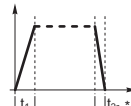
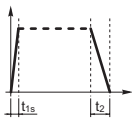
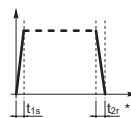
		Brake		
			Standard	At request
<b>BN 63</b>	<b>M05</b>	<b>FD 02</b>	<b>NB</b> 	<b>SB,</b>  <b>SBR,</b>  <b>NBR</b> 
<b>BN 71</b>	<b>M1</b>	<b>FD 03</b> <b>FD 53</b>		
<b>BN 80</b>	<b>M2</b>	<b>FD 04</b>		
<b>BN 90S</b>	—	<b>FD 14</b>		
<b>BN 90L</b>	—	<b>FD 05</b>		
<b>BN 100</b>	<b>M3</b>	<b>FD 15</b>		
—		<b>FD 55</b>		
<b>BN 112</b>	—	<b>FD 06S</b>	<b>SB</b> 	<b>SBR</b> 
<b>BN 132...160MR</b>	<b>M4</b>	<b>FD 56</b>		
<b>BN 160L - BN 180M</b>	<b>M5</b>	<b>FD 06</b>		
<b>BN 180L - NM 200L</b>	—	<b>FD 07</b>		

(\*)  $t_{2c} < t_{2r} < t_2$

## FD brake technical specifications

The table (C22) shows the technical specifications of DC brakes type FD.

(C22)

Brake	Brake torque $T_b$ [lb·in]			Release		Braking		$W_{max}$ per each brake operation			W [lb·ftx10 <sup>6</sup> ]	P [W]
	Springs			$t_1$	$t_{1s}$	$t_2$	$t_{2c}$	[lb·ft]				
	6	4	2	[ms]	[ms]	[ms]	[ms]	10 s/h	100 s/h	1000 s/h		
FD02	—	31	15	30	15	80	9	3300	1050	130	11	17
FD03	44	31	15	50	20	100	12	5200	1400	170	18	24
FD53	66	44	22	60	30	100	12					
FD04	133	88	44	80	35	140	15	7400	2300	260	27	33
FD14												
FD05	354	230	115	130	65	170	20	13300	3300	370	37	45
FD15	354	230	115	130	65	170	20					
FD55	487	327	159	—	65	170	20					
FD06S	831	354	177	—	80	220	25	15000	3500	400	52	55
FD56	—	664	327	—	90	150	20	21500	5500	600	59	65
FD06		885	443		100	150	20					
FD07	1328	885	443	—	120	200	25	29500	6900	750	96	65
FD08*	2200	1770	1500	—	140	350	30	44500	10300	1100	170	100
FD09**	3540	2650	1770	—	200	450	40	51500	7600	1250	170	120

\* brake torque values obtained with 9, 7 and 6 springs, respectively

\*\* brake torque values obtained with 12, 9 and 6 springs, respectively

Key:

$t_1$  = brake release time with half-wave rectifier

$t_{1s}$  = brake release time with over-energizing rectifier

$t_2$  = brake engagement time with AC line disconnect and separate power supply

$t_{2c}$  = brake engagement time with AC and DC line disconnect.

Values for  $t_1$ ,  $t_{1s}$ ,  $t_2$ ,  $t_{2c}$  indicated in the tab. (C23) are referred to brake set at maximum torque, medium air gap and rated voltage

$W_{max}$  = max energy per each brake operation

W = braking energy between two successive air gap adjustments

$P_b$  = brake power absorption at normal ambient temperature

$T_b$  = static braking torque ( $\pm 15\%$ )

= starts per hour

## FD brake connections

On standard single-speed motors, the rectifier is connected to the motor terminal board at the factory.

**Because the load is of the inductive type, brake control and DC line switch must use contacts from the usage class AC-3 to IEC 60947-4-1.**

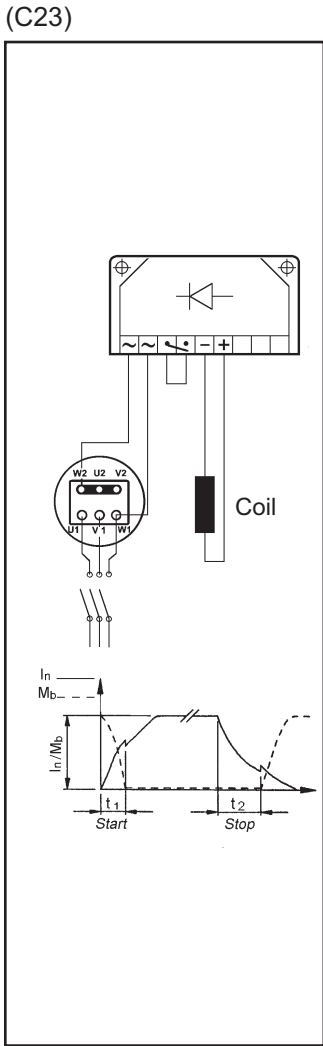

Brake supply from motor terminals and A.C. line disconnect. Longer stop time  $t_2$ , dependent on motor time constants. Use when no particular braking performance is required.

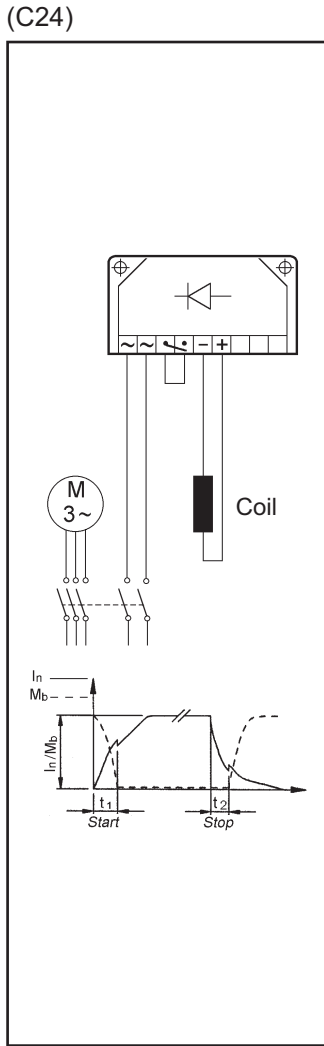

Separate power supply to brake coil and A.C. line disconnect. Stopping time is independent on motor. See table C22

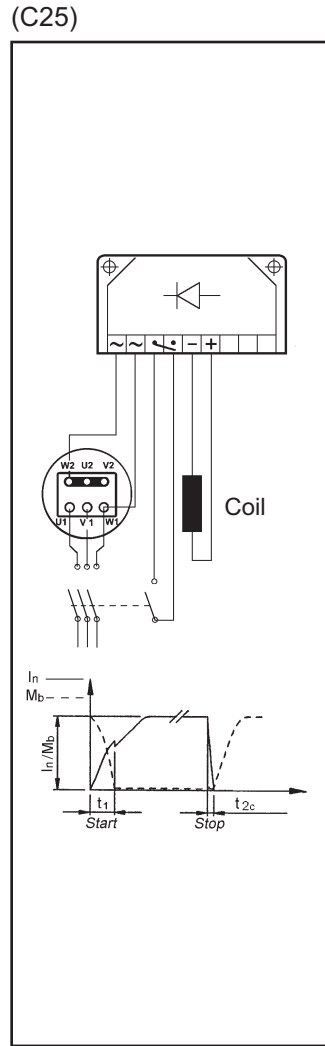

Brake coil energized from motor terminals, both A.C. and D.C. line switch off. Rapid stopping time,  $t_{2c}$ . See table C22

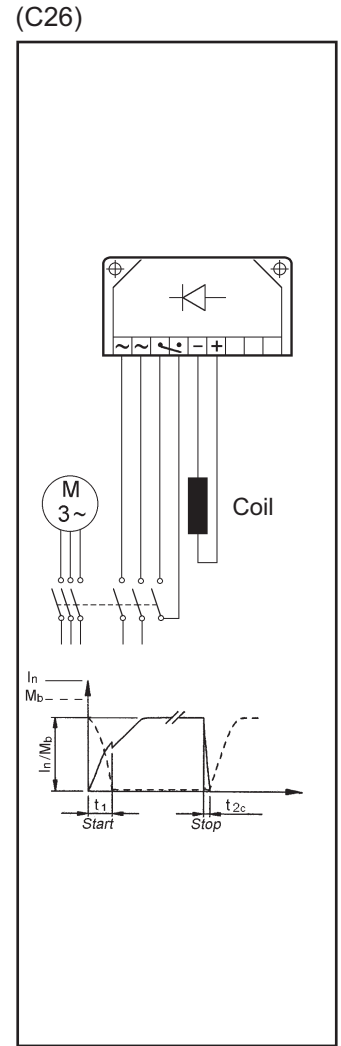

Separate power supply to brake coil. Both A.C. and D.C. line disconnect. Rapid stopping time to  $t_{2c}$  value, see table C22

## 3.7 AC BRAKE MOTORS TYPE BN\_FA

Frame sizes: BN 63 ... BN 180M

(C27)

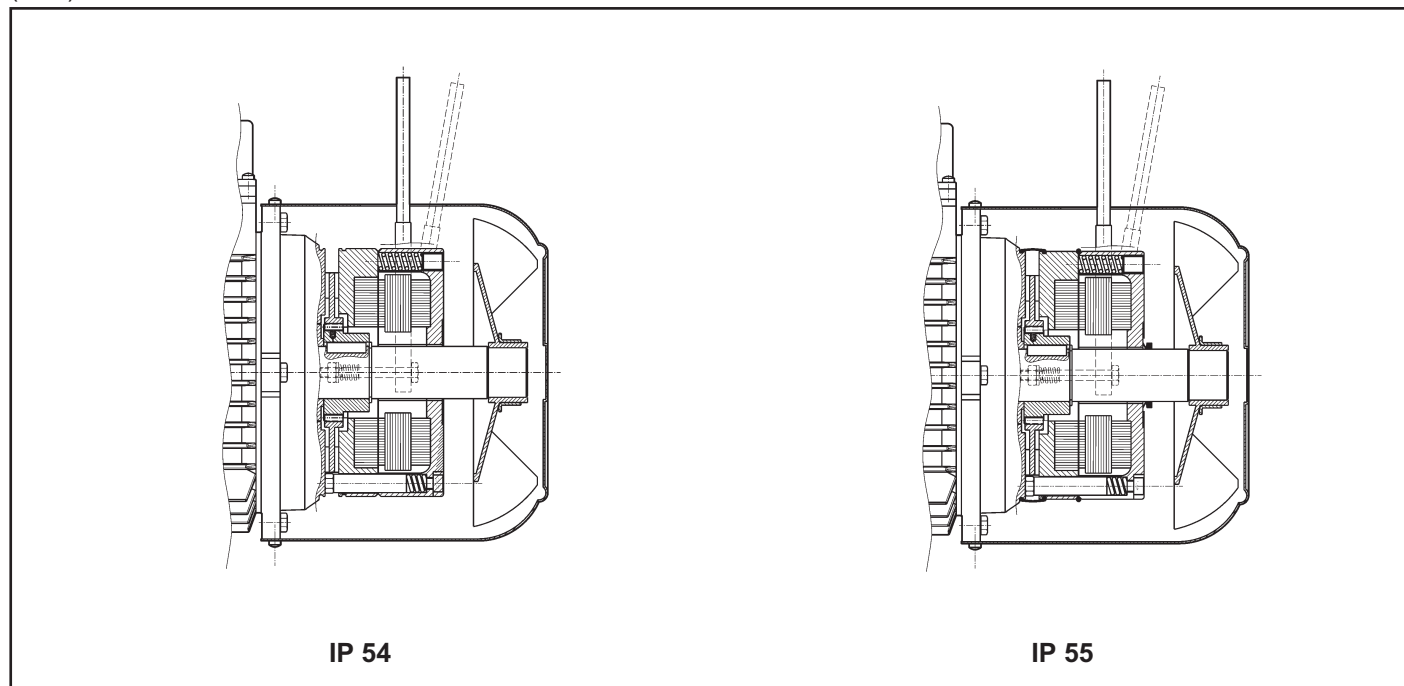

Electromagnetic brake operates from three-phase **alternated current** power supply and is bolted onto motor rear shield. Preloaded springs provide axial positioning of the magnet body.

Steel brake disc slides axially on steel hub fitted onto motor shaft with anti-vibration spring.

Brake torque factory setting is indicated in the corresponding motor rating charts.

Spring preloading screws provide stepless braking torque adjustment.

Torque adjustment range is  $30\% T_{bMAX} < T_b < T_{bMAX}$  (where  $T_{bMAX}$  is maximum braking torque as shown in tab. (C29).

Thanks to their high dynamic characteristics, FA brakes are ideal for heavy-duty applications as well as applications requiring frequent stop/starts and fast response time.

Motors may be equipped with manual release lever with automatic return (**R**) at request. See table (C33) for available lever locations.

### Degree of protection

Standard degree of protection is IP54.

Brake motor BN\_FA is also available with degree of protection **IP 55**, which incorporates the following variants:

- V-ring at N.D.E. of motor shaft
- water-proof rubber grommet
- O-ring

## FA brake power supply

Depending on motor voltage the brake may require the supply voltage to be specified, or not, as detailed in the

diagram below. Special voltages in the 24...690 V range may be available on request.

(C28)

Motor voltage - $V_{mot}$	Brake voltage - $V_B$	Specify	Brake wiring scheme	
230/460 V YY/Y 60 Hz	230 $\Delta$ - 60 Hz	<b>230SA</b>		
	460 Y - 60 Hz	<b>460SA</b>		
330/575 V $\Delta/Y$ 60 Hz	330/575 V $\Delta/Y$ 60 Hz	not required		

## Technical specifications of FA brakes

(C29)

Brake	Brake torque $T_b$ [lb-in]	Release $t_1$ [ms]	Braking $t_2$ [ms]	$W_{max}$ [lb-ft]			$W$ [lb-ftx10 <sup>6</sup> ]	$P_b$ [VA]
				10 s/h	100 s/h	1000 s/h		
FA 02	31	4	20	4500	1400	180	15	60
FA 03	66	4	40	7000	1900	230	25	80
FA 04	133	6	60	10000	3100	350	30	110
FA 14								
FA 05	354	8	90	18000	4500	500	50	250
FA 15								
FA 06S	530	16	120	20000	4800	550	70	470
FA 06	663	16	140	29000	7400	800	80	550
FA 07	1328	16	180	40000	9300	1000	130	600
FA 08	2200	20	200	60000	14000	1500	230	1200

Key:

$T_b$  = max static braking torque ( $\pm 15\%$ )

$t_1$  = brake release time

$t_2$  = brake engagement time

$W_{max}$  = max energy per brake operation (brake thermal capacity)

$W$  = braking energy between two successive air gap adjustments

$P_b$  = power drawn by brake at 20° (50 Hz)

[s/h] = starts per hour

NOTE

Values  $t_1$  and  $t_2$  in the table refer to a brake set at rated torque, medium air gap and rated voltage.

### 3.8 - BRAKE RELEASE SYSTEMS

Spring-applied brakes type **FD** and **FA** may be equipped with optional manual release devices. These are typically used for manually releasing the brake before servicing any machine or plant parts operated by the motor.

**R**

(C30)

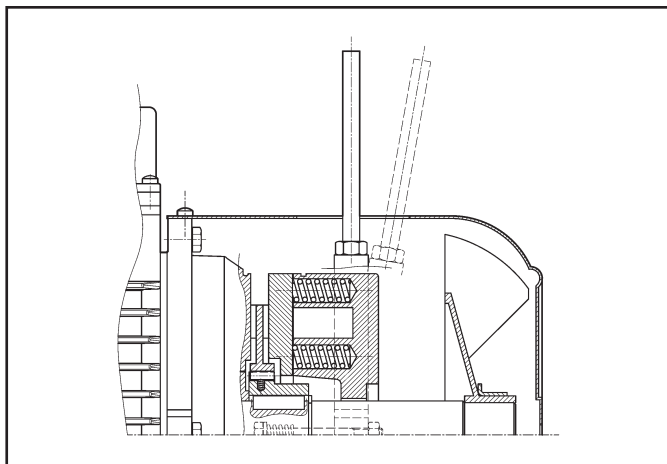

A return spring brings the release lever back in the original position.

**RM**

(C31)

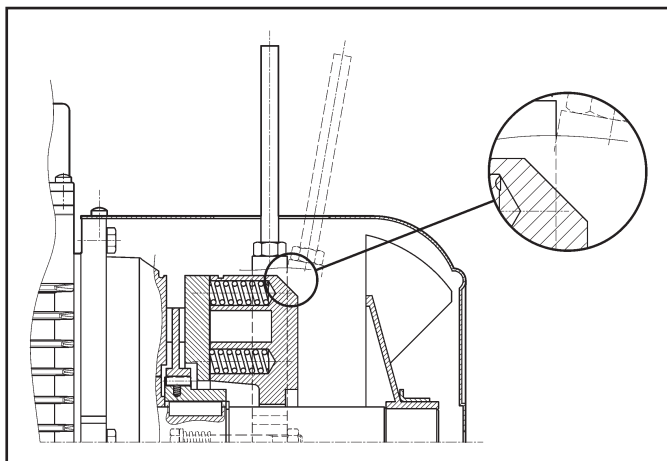

On motors type BN\_FD, if the option RM is specified, the release lever may be locked in the "release" position by tightening the lever until lever end becomes engaged with a brake housing projection.

The availability for the two lever options is charted here below:

(C32)

	R	RM
BN_FD	BN 63...BN 200	BN 63...BN 160MR
M_FD	M 05...M 5	M 05...M 4LC
BN_FA	BN 63...BN 180M	n.a.
M_FA	M 05...M 5	

#### Release lever arrangement

Unless otherwise specified, the release lever is located 90° away from the terminal box – identified by letters **[AB]** in the diagram below – in a clockwise direction on both options **R** and **RM**.

Alternative lever positions **[AA]**, **[AC]** and **[AD]** are also possible when the corresponding option is specified:

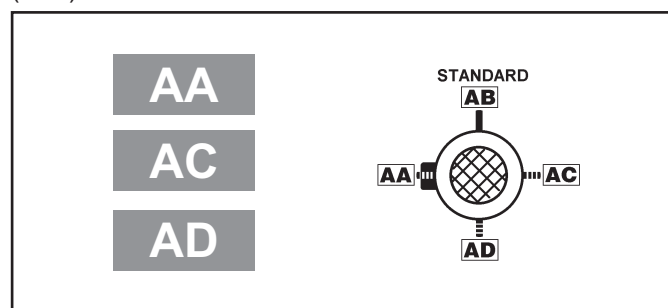

(C33)



#### Fly-wheel data (F1)

The table below shows values of weight and inertia of flywheel (option F1). Overall dimensions of motors remain unchanged. The option is available for DC brake-motors only.

(C34)

Main data for flywheel			
		Fly-wheel weight [lbs]	Fly-wheel inertia [lb • ft <sup>2</sup> ] x 10 <sup>-5</sup>
<b>BN 63</b>	<b>M05</b>	0.31	2.7
<b>BN 71</b>	<b>M1</b>	0.51	5.7
<b>BN 80</b>	<b>M2</b>	0.76	11.4
<b>BN 90</b> <b>BN 90 L</b>	–	1.14	22.3
<b>BN 100</b>	<b>M3</b>	1.58	35.4
<b>BN 112</b>	–	2.19	62.4
<b>BN 132 S</b> <b>BN 132 M</b>	<b>M4</b>	2.81	108.6

## 3.9 - OPTIONS

### Thermal protective devices

In addition to the standard protection provided by the magneto-thermal device, motors can be supplied with built-in thermal probes to protect the winding against overheating caused, by insufficient ventilation or by an intermittent duty.

This additional protection should always be specified for servoventilated motors (IC416).

### E3

### Thermistors

These are semi-conductors having rapid resistance variation when they are close to the rated switch off temperature.

Variations of the  $R = f(T)$  characteristic are specified under DIN 44081, IEC 34-11 Standards.

These elements feature several advantages: compact dimensions, rapid response time and, being contact-free, absolutely no wear.

Positive temperature coefficient thermistors are normally used (also known as PTC “cold conductor resistors”).

Unlike bimetallic thermostates, they cannot directly in-

tervene on currents of energizing coils, and must therefore be connected to a special control unit (triggering apparatus) to be interfaced with the external connections.

Thus protected, three PTCs connected in series are installed in the winding, the terminals of which are located on the auxiliary terminal-board.

### Bimetallic thermostates

These types of protective devices house a bimetal disk. When the rated switch off temperature is reached, the disk switches the contacts from their initial rest position. As temperature falls, the disk and the contacts automatically return to rest position.

Three bimetallic thermostates connected in series are usually employed, with normally closed contacts. The terminals are located in an auxiliary terminal-board.



### H1

### Anti-condensation heaters

Where an application involves high humidity or extreme temperature fluctuation, motors may be equipped with an anti-condensate heater.

A single-phase power supply is available in the auxiliary terminal board inside the main terminal box. Values for the absorbed power are listed here below:

(C35)

		H1 1~ 230V ± 10% P [W]
<b>BN 56...BN 80</b>	<b>M0...M2</b>	10
<b>BN 90...BN 160MR</b>	<b>M3 - M4</b>	25
<b>BN 160M...BN 180M</b>	<b>M5</b>	50
<b>BN 180L...BN 200L</b>	–	65

### Warning!

**Always disconnect power supply to the anti-condensate heater before operating the motor.**



**PS**

**Second shaft extension**

(C36)

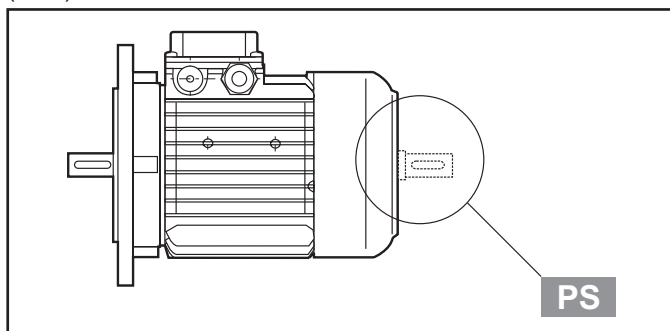

This option is not compatible with variants RC, TC, U1, U2, EN1, EN2, EN3. For shaft dimensions please see motor dimensions tables.

**AL**

**AR**

**Backstop device**

For applications where backdriving must be avoided, motors equipped with an anti run-back device can be used (available for the M series only).

While allowing rotation in the direction required, this device operates instantaneously in case of a power failure, preventing the shaft from running back.

The anti run-back device is life lubricated with special grease for this specific application.

When ordering, customers should indicate the required rotation direction, AL or AR.

Never use the anti run-back device to prevent reverse rotation caused by faulty electrical connection.

Table (C37) shows rated and maximum locking torques for the anti run-back devices.

A diagram of the device can be seen in Table (C38).

Overall dimensions are same as the corresponding brake motor.

(C37)

	Rated locking torque [lb·in]	Max. locking torque [lb·in]	Release speed [rpm]
<b>M1</b>	53	90	750
<b>M2</b>	140	240	650
<b>M3</b>	480	815	520
<b>M4</b>	970	1815	430

(C38)

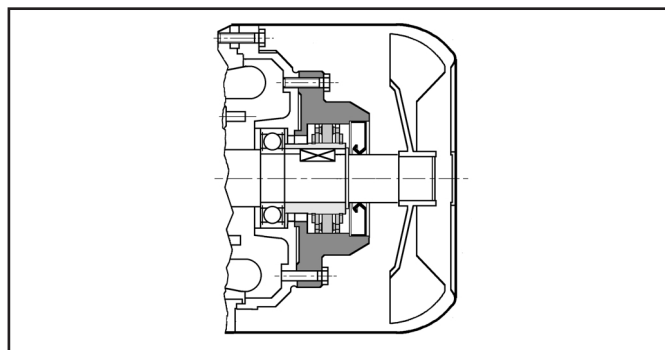

**Ventilation**

Motors are cooled through outer air blow (IC 411 according to CEI EN 60034-6) and are equipped with a plastic radial fan, which operates in both directions.

Ensure that fan cover is installed at a suitable distance from the closest wall so to allow air circulation and servicing of motor and brake, if fitted.



On request, motors can be supplied with independently power-supplied forced ventilation system starting from BN 71 or M1 size.

Motor is cooled by an axial fan with independent power supply and fitted on the fan cover (IC 416 cooling system).

This option comes handy for inverter driven motors so that constant torque operation is possible even at low speed or when high starting frequencies are needed.

Motors with rear shaft projection (PS option) are excluded.

(C39)



Power supply					
		V a.c. ± 10%	Hz	P [W]	I [A]
<b>BN 71</b>	<b>M1</b>	1~ 230	50 / 60	22	0.14
<b>BN 80</b>	<b>M2</b>			22	0.14
<b>BN 90</b>	–			40	0.25
<b>BN 100 (*)</b>	<b>M3</b>			50	0.25
<b>BN 112</b>	–	3~ 230 Δ / 400Y	50 / 60	50	0.26 / 0.15
<b>BN 132S</b>	<b>M4S</b>			110	0.38 / 0.22
<b>BN 132M... BN160MR</b>	<b>M4L</b>				
<b>BN 160... BN 180M</b>	<b>M5</b>	3~460	60	210	1.25 / 0.72



This variant features two options, designated **U1** and **U2**, having the same length overall.

Longer side of fan cover ( $\Delta L$ ) is specified for both models in the table below. Overall dimension can be reckoned from motor size table.

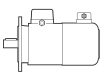
(C40)

Extra length for servoventilated motors [in]			
		$\Delta L_1$ add for standard motor	$\Delta L_2$ add for brakemotor
<b>BN 71</b>	<b>M1</b>	3.66	1.26
<b>BN 80</b>	<b>M2</b>	5.00	2.17
<b>BN 90</b>	–	5.16	1.89
<b>BN 100</b>	<b>M3</b>	4.69	1.10
<b>BN 112</b>	–	5.12	1.22
<b>BN 132S</b>	<b>M4S</b>	6.34	2.01
<b>BN 132M</b>	<b>M4L</b>	6.34	2.01

**U1**



Fan wiring terminals are housed in a separate terminal box.

In brake motors of size BN 71...BN 160MR, with **U1** model, the release lever cannot be positioned to AA.



**U2**



Fan terminals are wired in the motor terminal box.

The U2 option does not apply to motors BN 160 through BN 200L, with the only exception of motor BN 160MR for which the option is available instead and to motors with option CUS (compliant to norms CSA and UL)..

(C41)

			V a.c. $\pm 10\%$	Hz	P [W]	I [A]
(*)	<b>BN 100_U2</b>	<b>M3</b>	3~ 230 $\Delta$ / 400Y	50/60	40	0.24 / 0.14

**RC**



## Drip cover

The drip cover protects the motor from dripping and avoids the ingress of solid bodies. It is recommended when motor is installed in a vertical position with the shaft downwards.

Relevant dimensions are indicated in the table (C42).

The drip cover is not compatible with variants PS, EN1, EN2, EN3.

(C42)

		<b>AQ</b> [in]	$\Delta V$ [in]
<b>BN 63</b>	<b>M05</b>	4.65	0.95
<b>BN 71</b>	<b>M1</b>	5.28	1.06
<b>BN 80</b>	<b>M2</b>	5.98	0.98
<b>BN 90</b>	–	6.61	1.18
<b>BN 100</b>	<b>M3</b>	7.48	1.10
<b>BN 112</b>	–	8.31	1.26
<b>BN 132...BN 160MR</b>	<b>M4</b>	10.00	1.26
<b>BN 160M...BN 180M</b>	<b>M5</b>	11.89	1.42
<b>BN 180L...BN 200L</b>	–	13.39	1.42

(C43)

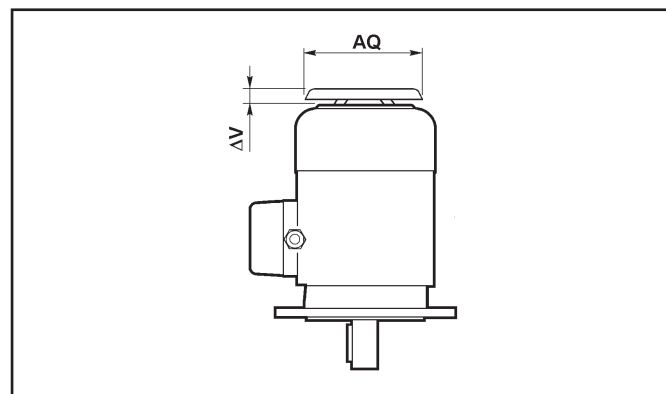

**TC**

## Textile canopy

Option TC is a cover variant for textile industry environments, where lint may obstruct the fan grid and prevent a regular flow of cooling air.

This option is not compatible with variants EN1, EN2, EN3. Overall dimensions are the same as drip cover type RC.

## Feedback units

Motors may be combined with three different types of encoders to achieve feedback circuits.

Configurations with double-extended shaft (PS) and rain canopy (RC, TC) are not compatible with the installation of the encoder.

### EN1

Incremental encoder,  $V_{IN}=5\text{ V}$ , line-driver output RS 422.

### EN2

Incremental encoder,  $V_{IN}=10\text{-}30\text{ V}$ , line-driver output RS 422.

### EN3

Incremental encoder,  $V_{IN}=12\text{-}30\text{ V}$ , push-pull output 12-30 V.

(C44)

	EN1	EN2	EN3
Interface	RS 422	RS 422	push-pull
Power supply voltage [V]	4...6	10...30	12...30
Output voltage [V]	5	5	12...30
No-load operating current [mA]	120	100	100
No. of pulses per revolution	1024		
No. of signals	6 (A, B, C + inverted signals)		
Max. output frequency [kHz]	300	300	200
Max. speed [rpm]	600 (900 rpm x 10s)		
Temperature range [°C]	-20...+70		
Protection class	IP 65		

(C45)

EN1, EN2, EN3	
BN 63...BN 200L	M05...M5
BN 63_FD...BN 200L_FD	M05_FD...M5_FD
BN 63_FA...BN 200L_FA	M05_FA...M5_FA

(C46)

EN_ + U1		L3
BN 160M...BN 180M	M5	2.835
BN 180L...BN 200L	-	3.228
BN 160M_FD...BN 180M_FD	M5_FD	1.378
BN 180L_FD...BN 200L_FD	-	1.614

If the encoder device (options EN1, EN2, EN3) is specified on motors BN71...BN160MR and M1...M4, along with the independent fan cooling (options U1, U2), the extra length of motor is coincident with that of the correspondent U1 and U2 execution.

## 3.10 COMPACT MOTOR RATING CHARTS

### 2 POLE - 3600 rpm - S1

### 60 HZ

P <sub>n</sub>	HP	kW		n	T <sub>n</sub>	η	cosφ	I <sub>n</sub> at 460V	I <sub>s</sub> I <sub>n</sub>	T <sub>s</sub> T <sub>n</sub>	T <sub>k</sub> T <sub>n</sub>	J <sub>m</sub>		Weight lbs	Brake type	T <sub>b</sub>	Z <sub>0</sub> 1/h	Weight lbs	Brake type	T <sub>b</sub>	Z <sub>0</sub> 1/h	Weight lbs	
												1)	2)										
0.25	0.18	0.18	<b>M 05A 2</b>	3380	4.7	60	0.74	0.53	410	300	320	0.0048	0.0062	7.1	<b>FD 02</b>	15	3300	10.8	<b>FA 02</b>	15	3300	10.4	
0.33	0.25	0.25	<b>M 05B 2</b>	3400	6.1	65	0.75	0.63	490	320	330	0.0055	0.0071	7.9	<b>FD 02</b>	15	3300	11.7	<b>FA 02</b>	15	3300	11.2	
0.5	0.37	0.37	<b>M 05C 2</b>	3420	9.2	69	0.76	0.89	550	330	350	0.0062	0.0078	10.6	<b>FD 02</b>	30	3000	14.3	<b>FA 02</b>	30	3000	13.9	
0.75	0.55	0.55	<b>M 1SD 2</b>	3450	13.7	76	0.75	1.23	620	340	390	0.0097	0.0126	12.8	<b>FD 03</b>	44	2200	18.7	<b>FA 03</b>	44	2700	18.1	
1	0.75	0.75	<b>M 1LA 2</b>	3440	18.3	77	0.75	1.62	620	380	410	0.0119	0.0145	15.2	<b>FD 03</b>	44	1500	21	<b>FA 03</b>	44	2100	21	
1.5	1.1	1.1	<b>M 2SA 2</b>	3430	27.6	77	0.76	2.40	620	380	390	0.0214	0.0252	19.4	<b>FD 04</b>	88	1200	28	<b>FA 04</b>	88	1600	28	
2	1.5	1.5	<b>M 2SB 2</b>	3420	36.8	80	0.81	2.89	600	330	350	0.0271	0.0309	23	<b>FD 04</b>	133	1000	32	<b>FA 04</b>	133	1300	32	
3	2.2	2.2	<b>M 3SA 2</b>	3430	55	81	0.83	4.2	600	240	250	0.0570	0.0665	34	<b>FD 15</b>	230	800	49	<b>FA 15</b>	230	1000	51	
5	3.7	3.7	<b>M 3LB 2</b>	3490	92	84	0.83	6.7	670	290	320	0.0926	0.102	49	<b>FD 15</b>	354	360	62	<b>FA 15</b>	354	500	64	
7.5	5.5	5.5	<b>M 4SA 2</b>	3490	135	83	0.86	9.8	640	270	300	0.240	0.266	72	<b>FD 06</b>	440	400	101	<b>FA 06</b>	440	400	104	
10	7.5	7.5	<b>M 4SB 2</b>	3490	181	82	0.88	13.0	620	280	320	0.318	0.344	88	<b>FD 06</b>	440	350	117	<b>FA 06</b>	440	350	143	
15	11	11	<b>M 4LC 2</b>	3510	271	87	0.88	18.3	690	270	300	0.499		132									
20	15	15	<b>M 5SB 2</b>	3510	359	86	0.90	24.2	600	250	270	0.808		154									
25	18.5	18.5	<b>M 5SC 2</b>	3520	449	88	0.91	29.2	690	280	300	0.998		183									
30	22	22	<b>M 5LA 2</b>	3520	537	88	0.91	35.1	690	280	310	1.164		209									

1) Inertia without brake

2) Inertia with brake

3) Permissible starts with NB rectifier (AC/DC)

4) Permissible starts with SB rectifier (AC/DC)

### 4 POLE - 1800 rpm - S1

## 60 HZ

HP	P <sub>n</sub> kW		n rpm	T <sub>n</sub> lb-in	η %	cosφ	I <sub>n</sub> at 460V A	I <sub>s</sub> I <sub>n</sub> %	T <sub>s</sub> T <sub>n</sub> %	T <sub>k</sub> T <sub>n</sub> %	J <sub>m</sub> lb-ft <sup>2</sup>		Weight lbs 1)	Brake type	T <sub>b</sub> lb-in	Z <sub>o</sub> 1/h		Weight lbs 2)	Brake type	T <sub>b</sub> lb-in	Z <sub>o</sub> 1/h		Weight lbs 2)		
											1)	2)				3)	4)				3)	4)			
0.12	0.09	<b>M 0B 4</b>	1670	4.5	59	0.52	0.37	280	290	290	0.0356		6.4												
0.16	0.12	<b>M 05A 4</b>	1690	6.0	60	0.57	0.44	330	240	250	0.0048	0.0062	7.1	<b>FD 02</b>	15	7000	9000	10.8	<b>FA 02</b>	15	7000	9000	10.4		
0.25	0.18	<b>M 05B 4</b>	1670	9.4	58	0.60	0.65	320	280	290	0.0055	0.0071	7.9	<b>FD 02</b>	30	7000	9000	11.7	<b>FA 02</b>	30	7000	9000	11.2		
0.33	0.25	<b>M 05C 4</b>	1670	12.4	64	0.64	0.77	330	250	260	0.0078	0.0093	10.6	<b>FD 02</b>	30	6000	8000	14.3	<b>FA 02</b>	30	6000	8000	13.9		
0.50	0.37	<b>M 1SD 4</b>	1700	18.5	66	0.73	0.96	450	260	280	0.0164	0.0190	12.1	<b>FD 03</b>	44	4800	7500	18.1	<b>FA 03</b>	44	4800	7500	17.4		
0.75	0.55	<b>M 1LA 4</b>	1710	27.6	72	0.70	1.37	490	300	310	0.0216	0.0242	15.2	<b>FD 53</b>	66	3400	7000	21	<b>FA 53</b>	66	3400	7000	21		
1	0.75	<b>M 2SA 4</b>	1720	36.6	78	0.75	1.61	620	340	350	0.0482	0.0523	20	<b>FD 04</b>	133	3000	6000	29	<b>FA 04</b>	133	3000	6000	29		
1.5	1.1	<b>M 2SB 4</b>	1720	55	78	0.76	2.33	630	340	350	0.0594	0.0641	23	<b>FD 04</b>	133	2000	4200	32	<b>FA 04</b>	133	2000	4200	32		
2	1.5	<b>M 3SA 4</b>	1720	73	82	0.73	3.15	570	290	330	0.0808	0.0903	34	<b>FD 15</b>	230	1500	3000	49	<b>FA 15</b>	230	1500	3000	51		
3	2.2	<b>M 3LA 4</b>	1720	110	81	0.73	4.67	550	270	290	0.0960	0.105	37	<b>FD 15</b>	354	1000	2700	53	<b>FA 15</b>	354	1000	2700	53		
5	3.7	<b>M 3LC 4</b>	1730	182	84	0.74	7.5	560	280	310	0.145	0.154	51	<b>FD 55</b>	480		1200	64	<b>FA 55</b>	480		1200	66		
7.5	5.5	<b>M 4SA 4</b>	1730	273	84	0.84	9.8	630	290	310	0.506	0.530	93	<b>FD 56</b>	664	850	850	121	<b>FA 06</b>	664	850	850	124		
10	7.5	<b>M 4LA 4</b>	1740	362	85	0.84	13.2	610	290	300	0.641	0.665	112	<b>FD 06</b>	885	700	700	141	<b>FA 06</b>	885	700	700	143		
15	11	<b>M 4LC 4</b>	1740	543	88	0.81	19.4	650	310	320	0.855	0.907	143	<b>FD 07</b>	1328	600	600	179	<b>FA 07</b>	1328	600	600	183		
20	15	<b>M 5SB 4</b>	1750	720	90	0.84	24.9	580	230	270	1.544	1.781	187	<b>FD 08</b>	1770	400	400	254	<b>FA 08</b>	1770	400	400	251		
25	18.5	<b>M 5LA 4</b>	1760	895	90	0.83	31.1	580	250	310	1.876	2.054	223	<b>FD 08</b>	2210	300	300	289	<b>FA 08</b>	2210	300	300	287		

1) Inertia without brake

2) Inertia with brake

3) Permissible starts with NB rectifier (AC/DC)

4) Permissible starts with SB rectifier (AC/DC)

## 6 POLE - 1200 rpm - S1

60 HZ

P <sub>n</sub>		n rpm	T <sub>n</sub> lb-in	η %	cosφ	I <sub>n</sub> at 460V A	I <sub>s</sub> I <sub>n</sub> %	T <sub>s</sub> T <sub>n</sub> %	T <sub>k</sub> T <sub>n</sub> %	J <sub>m</sub> lb-ft <sup>2</sup>		Weight lbs 1)	Brake type	T <sub>b</sub> lb-in	Z <sub>0</sub> 1/h 3)	Weight lbs 1)	Brake type	T <sub>b</sub> lb-in	Z <sub>0</sub> 1/h 4)	Weight lbs 2)	
										1)	2)										
0.12	0.09	<b>M 05A 6</b>	1100	6.9	47	0.46	240	290	290	0.0081	0.0095	9.5	<b>FD 02</b>	30	7000	10000	13.2	<b>FA 02</b>	30	10000	12.8
0.16	0.12	<b>M 05B 6</b>	1100	9.2	49	0.54	230	240	240	0.0088	0.0102	10.1	<b>FD 02</b>	30	7000	10000	13.9	<b>FA 02</b>	30	10000	13.4
0.25	0.18	<b>M 15C 6</b>	1100	14.3	61	0.65	330	260	280	0.0200	0.0226	11.2	<b>FD 03</b>	44	6500	10000	17.2	<b>FA 03</b>	44	10000	16.5
0.33	0.25	<b>M 15D 6</b>	1100	18.9	64	0.65	320	260	270	0.0259	0.0290	13.9	<b>FD 03</b>	44	6200	8000	19.8	<b>FA 03</b>	44	8000	19.2
0.50	0.37	<b>M 15A 6</b>	1100	28.6	66	0.65	330	260	270	0.0306	0.0330	16.1	<b>FD 53</b>	66	4000	7000	22	<b>FA 03</b>	66	7000	21
0.75	0.55	<b>M 25A 6</b>	1140	41.4	76	0.66	490	320	340	0.0594	0.0641	23	<b>FD 04</b>	133	3800	5000	32	<b>FA 04</b>	133	5000	32
1	0.75	<b>M 25B 6</b>	1140	55	76	0.61	440	280	300	0.0665	0.0713	25	<b>FD 04</b>	133	2700	5000	34	<b>FA 04</b>	133	5000	34
1.5	1.1	<b>M 35A 6</b>	1140	83	74	0.68	440	240	280	0.147	0.157	37	<b>FD 15</b>	230	2300	4500	51	<b>FA 15</b>	230	4500	53
2	1.5	<b>M 35A 6</b>	1140	111	76	0.66	450	240	280	0.195	0.204	46	<b>FD 15</b>	354	1500	3000	60	<b>FA 15</b>	354	3000	62
3	2.2	<b>M 35C 6</b>	1140	166	77	0.68	510	260	290	0.226	0.235	51	<b>FD 55</b>	480	1500	1500	64	<b>FA 15</b>	480	1500	66
5	3.7	<b>M 45A 6</b>	1150	274	80	0.79	610	250	310	0.701	0.724	95	<b>FD 06</b>	885	900	900	123	<b>FA 06</b>	885	900	126
7.5	5.5	<b>M 45B 6</b>	1140	414	82	0.75	540	270	290	0.910	0.964	119	<b>FD 07</b>	1328	800	800	154	<b>FA 07</b>	1328	800	159
10	7.5	<b>M 55A 6</b>	1160	543	85	0.82	580	230	280	1.758	1.936	152	<b>FD 08</b>	1500	550	550	216	<b>FA 08</b>	1500	550	216
15	11	<b>M 55B 6</b>	1160	815	84	0.83	580	250	290	2.304	2.482	196	<b>FD 08</b>	1770	400	400	262	<b>FA 08</b>	1770	400	260

1) Inertia without brake  
2) Inertia with brake

3) Permissible starts with NB rectifier (AC/DC)  
4) Permissible starts with SB rectifier (AC/DC)

### 3.11 IEC MOTOR RATING CHARTS

#### 2 POLE - 3600 rpm - S1

**60 Hz**

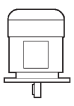
P <sub>n</sub> HP	P <sub>n</sub> kW		n rpm	T <sub>n</sub> lb-in	η %	cosφ	I <sub>n</sub> at 460V A	I <sub>s</sub> I <sub>n</sub> %	T <sub>s</sub> T <sub>n</sub> %	T <sub>k</sub> T <sub>n</sub> %	J <sub>m</sub> lb-ft <sup>2</sup>	Weight lbs	Brake type	T <sub>b</sub> lb-in	Z <sub>o</sub> 1/h	Weight lbs	Brake type	T <sub>b</sub> lb-in	Z <sub>o</sub> 1/h	Weight lbs
0.25	0.18	<b>BN 63A</b>	2	3360	58	0.74	0.55	370	290	300	0.0048	7.7	<b>FD 02</b>	15	2700	10.7	<b>FA 02</b>	15	3300	11.0
0.33	0.25	<b>BN 63B</b>	2	3370	61	0.73	0.69	420	290	300	0.0055	8.6	<b>FD 02</b>	15	2700	11.5	<b>FA 02</b>	15	3300	11.9
0.5	0.37	<b>BN 71A</b>	2	3420	71	0.77	0.86	580	330	380	0.0082	11.9	<b>FD 03</b>	30	2400	16.6	<b>FA 03</b>	30	3200	17.2
0.75	0.55	<b>BN 71B</b>	2	3450	76	0.75	1.23	620	340	390	0.0097	13.7	<b>FD 03</b>	44	2200	18.2	<b>FA 03</b>	44	2700	19.0
1	0.75	<b>BN 80A</b>	2	3440	76	0.76	1.62	590	310	370	0.0185	19.0	<b>FD 04</b>	44	1400	26	<b>FA 04</b>	44	1700	27
1.5	1.1	<b>BN 80B</b>	2	3430	77	0.76	2.40	620	380	390	0.0214	21	<b>FD 04</b>	88	1200	27	<b>FA 04</b>	88	1600	29
2	1.5	<b>BN 90SA</b>	2	3480	79	0.78	3.04	730	360	380	0.0297	27	<b>FD 14</b>	133	750	34	<b>FA 14</b>	133	1000	36
3	2.2	<b>BN 90L</b>	2	3490	81	0.79	4.4	730	380	390	0.0397	31	<b>FD 05</b>	230	750	41	<b>FA 05</b>	230	1000	46
5	3.7	<b>BN 100LB</b>	2	3490	84	0.83	6.7	670	290	320	0.0926	51	<b>FD 15</b>	354	360	59	<b>FA 15</b>	354	500	66
7.5	5.5	<b>BN 132SA</b>	2	3490	83	0.86	9.8	640	270	300	0.240	77	<b>FD 06</b>	440	400	98	<b>FA 06</b>	440	400	108
10	7.5	<b>BN 132SB</b>	2	3490	82	0.88	13.0	620	280	320	0.318	93	<b>FD 06</b>	440	350	113	<b>FA 06</b>	440	350	123
15	11	<b>BN 160MR</b>	2	3510	87	0.88	18.3	690	270	300	0.499	143								
20	15	<b>BN 160MB</b>	2	3510	86	0.90	24.2	600	250	270	0.808	185								
25	18.5	<b>BN 160L</b>	2	3520	88	0.91	29.2	690	280	300	0.998	214								
30	22	<b>BN 180M</b>	2	3520	88	0.91	35.1	690	280	310	1.164	240								
40	30	<b>BN 200L</b>	2	3530	89	0.91	46.2	690	260	300	1.829	309								

1) Inertia without brake  
2) Inertia with brake

3) Permissible starts with NB rectifier (AC/DC)  
4) Permissible starts with SB rectifier (AC/DC)

## 4 POLE - 1800 rpm - S1

60 HZ

P <sub>n</sub>	HP	kW		n	T <sub>n</sub>	η	cosφ	I <sub>n</sub> at 460V	I <sub>s</sub> I <sub>n</sub>	T <sub>s</sub> T <sub>n</sub>	T <sub>k</sub> T <sub>n</sub>	J <sub>m</sub>		Weight lbs	Brake type	T <sub>b</sub>	Z <sub>o</sub>		Weight lbs	Brake type	T <sub>b</sub>	Z <sub>o</sub> 1/h	Weight lbs	
												1)	2)				3)	4)						
0.08	0.06	<b>BN 56A</b>	4	1670	3.0	53	0.55	0.26	290	310	310	0.0036		6.8										
0.12	0.09	<b>BN 56B</b>	4	1670	4.5	59	0.52	0.37	280	290	290	0.0036		6.8										
0.16	0.12	<b>BN 63A</b>	4	1650	6.1	55	0.64	0.43	310	240	250	0.0048	0.0062	7.7	FD 02	15	7000	9000	11.5	FA 02	15	9000	11.0	
0.25	0.18	<b>BN 63B</b>	4	1670	9.4	58	0.59	0.68	310	280	290	0.0055	0.0071	8.6	FD 02	30	7000	9000	12.3	FA 02	30	9000	11.9	
0.33	0.25	<b>BN 71A</b>	4	1700	12.2	64	0.74	0.65	430	260	270	0.0138	0.0164	11.2	FD 03	30	6000	8500	17.2	FA 03	30	8500	16.5	
0.50	0.37	<b>BN 71B</b>	4	1700	18.5	66	0.73	0.97	450	260	280	0.0164	0.0190	13.0	FD 03	44	4800	7500	19.0	FA 03	44	7500	18.3	
0.75	0.55	<b>BN 80A</b>	4	1710	27.6	73	0.75	1.28	490	300	300	0.0356	0.0394	18.1	FD 04	89	3400	7000	27	FA 04	89	7000	26	
1	0.75	<b>BN 80B</b>	4	1720	36.6	78	0.75	1.60	620	340	350	0.0482	0.0523	22	FD 04	133	3000	6000	30	FA 04	133	6000	30	
1.5	1.1	<b>BN 90S</b>	4	1720	55	78	0.74	2.43	570	310	340	0.0499	0.0546	27	FD 14	133	3000	7000	36	FA 14	133	7000	36	
2	1.5	<b>BN 90LA</b>	4	1720	73	81	0.74	3.12	660	330	360	0.0665	0.0760	30	FD 05	230	2200	4700	43	FA 05	230	4700	45	
3	2.2	<b>BN 100LA</b>	4	1720	110	81	0.73	4.8	550	270	290	0.0960	0.105	40	FD 15	354	1000	2700	55	FA 15	354	2700	55	
5	3.7	<b>BN 100LC</b>	4	1730	182	84	0.74	7.5	560	280	310	0.145	0.154	55	FD 55	480	1200	1200	66	FA 15	480	1200	64	
5.5	4	<b>BN 112M</b>	4	1730	200	85	0.76	8.0	700	310	340	0.233	0.254	66	FD 06S	530	850	850	88	FA 06S	530	850	93	
7.5	5.5	<b>BN 132S</b>	4	1730	273	84	0.84	10.0	630	290	310	0.506	0.530	97	FD 56	664	850	850	126	FA 06	664	850	128	
10	7.5	<b>BN 132MA</b>	4	1740	362	85	0.84	13.1	610	290	300	0.641	0.665	117	FD 06	885	700	146	FA 07	885	700	157		
15	11	<b>BN 160MR</b>	4	1740	543	88	0.81	19.4	650	310	320	0.855	0.907	154	FD 07	1328	600	190	FA 07	1328	600	194		
20	15	<b>BN 160L</b>	4	1750	720	90	0.84	24.8	580	230	270	1.544	1.722	218	FD 08	1770	400	284	FA 08	1770	400	282		
25	18.5	<b>BN 180M</b>	4	1760	895	90	0.83	31.3	580	250	310	1.876	2.054	254	FD 08	2210	300	320	FA 08	2210	300	317		

1) Inertia without brake

2) Inertia with brake

3) Permissible starts with NB rectifier (AC/DC)

4) Permissible starts with SB rectifier (AC/DC)



**6 POLE - 1200 rpm - S1**
**60 Hz**

P <sub>n</sub>		n rpm	T <sub>n</sub> lb-in	η %	cosφ	I <sub>n</sub> at 460V A	I <sub>s</sub> I <sub>n</sub> %	T <sub>s</sub> T <sub>n</sub> %	T <sub>k</sub> T <sub>n</sub> %	J <sub>m</sub> lb-ft <sup>2</sup>		Weight lbs 1)	Brake type	T <sub>b</sub> lb-in	Z <sub>0</sub> 1/h		Weight lbs 2)	Brake type	T <sub>b</sub> lb-in	Z <sub>0</sub> 1/h		Weight lbs 2)
										1)	2)				3)	4)				3)	4)	
0.12	0.09	<b>BN 63A</b>	6	1100	47	0.50	0.48	280	290	0.0081	0.0095	10.1	<b>FD 02</b>	30	7000	10000	13.9	<b>FA 02</b>	30	10000	10000	13.4
0.16	0.12	<b>BN 63B</b>	6	1100	50	0.55	0.55	240	270	0.0088	0.0102	10.8	<b>FD 02</b>	30	7000	10000	14.6	<b>FA 02</b>	30	10000	10000	14.1
0.25	0.18	<b>BN 71A</b>	6	1100	61	0.65	0.57	330	260	0.0200	0.0226	12.1	<b>FD 03</b>	44	6500	10000	18.1	<b>FA 03</b>	44	10000	10000	17.4
0.33	0.25	<b>BN 71B</b>	6	1100	64	0.65	0.75	320	270	0.0259	0.0285	14.8	<b>FD 03</b>	44	6200	8000	21	<b>FA 03</b>	44	8000	8000	20
0.50	0.37	<b>BN 80A</b>	6	1130	67	0.65	1.07	390	260	0.0499	0.0546	22	<b>FD 04</b>	88	4100	5500	30	<b>FA 04</b>	88	5500	5500	30
0.75	0.55	<b>BN 80B</b>	6	1140	76	0.66	1.38	490	320	0.0594	0.0641	25	<b>FD 04</b>	133	3800	5000	34	<b>FA 04</b>	133	5000	5000	33
1	0.75	<b>BN 90S</b>	6	1140	73	0.63	2.05	450	290	0.0618	0.0665	29	<b>FD 14</b>	133	2700	4000	37	<b>FA 14</b>	133	4000	4000	37
1.5	1.1	<b>BN 90L</b>	6	1140	75	0.65	2.83	430	280	0.0784	0.0879	33	<b>FD 05</b>	230	2000	3500	46	<b>FA 05</b>	230	3500	3500	49
2	1.5	<b>BN 100LA</b>	6	1140	76	0.66	3.75	450	240	0.195	0.204	49	<b>FD 15</b>	354	1500	3000	62	<b>FA 15</b>	354	3000	3000	64
3	2.2	<b>BN 112M</b>	6	1150	81	0.69	4.9	550	280	0.400	0.420	71	<b>FD 06S</b>	530		1250	93	<b>FA 06S</b>	530	1250	1250	97
5.0	3.7	<b>BN 132MA</b>	6	1150	80	0.79	7.3	610	250	0.701	0.724	97	<b>FD 06</b>	885		900	128	<b>FA 07</b>	885	900	900	139
7.5	5.5	<b>BN 132MB</b>	6	1140	82	0.75	11.2	540	270	0.910	0.964	123	<b>FD 07</b>	1328		800	159	<b>FA 07</b>	1328	800	800	163
10	7.5	<b>BN 160M</b>	6	1160	85	0.82	13.5	580	230	1.758	1.936	183	<b>FD 08</b>	1500		550	247	<b>FA 08</b>	1500	550	550	249
15	11	<b>BN 160L</b>	6	1160	84	0.83	19.8	580	250	2.304	2.482	227	<b>FD 08</b>	1770		400	293	<b>FA 08</b>	1770	400	400	293

1) Inertia without brake  
2) Inertia with brake

3) Permissible starts with NB rectifier (AC/DC)  
4) Permissible starts with SB rectifier (AC/DC)



### 3.12 DIMENSIONS

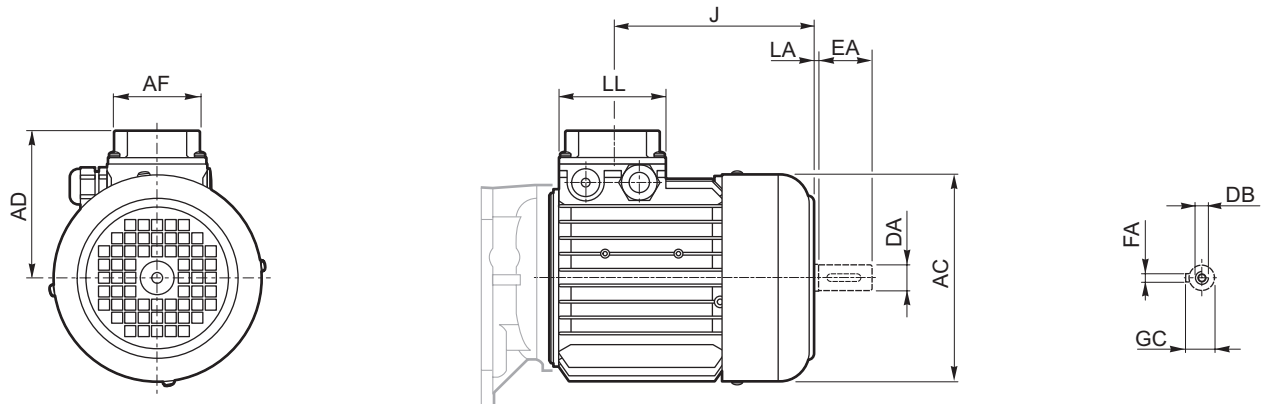

	AC	AD	AF	LL	J	DA	EA	LA	DB	GC	FA
<b>M 0</b>	4.33 110	3.58 91	2.91 74	3.15 80	3.58 91	0.35 9	0.79 20	0.08 2	M3	0.40 10.2	0.12 3
<b>M 05</b>	4.76 121	3.74 95	2.91 74	3.15 80	4.61 117	0.43 11	0.91 23	0.12 3	M4	0.49 12.5	0.16 4
<b>M 1S</b>	5.43 138	4.25 108	2.91 74	3.15 80	4.65 118	0.55 14	1.18 30	0.08 2	M5	0.63 16	0.20 5
<b>M 1L</b>	5.43 138	4.25 108	2.91 74	3.15 80	5.59 142	0.55 14	1.18 30	0.08 2	M5	0.63 16	0.20 5
<b>M 2S</b>	6.14 156	4.69 119	2.91 74	3.15 80	5.98 152	0.75 19	1.57 40	0.12 3	M6	0.85 21.5	0.24 6
<b>M 3S</b>	7.68 195	5.59 142	3.86 98	3.86 98	6.95 176.5	1.10 28	2.36 60	0.12 3	M10	1.22 31	0.31 8
<b>M 3L</b>	7.68 195	5.59 142	3.86 98	3.86 98	8.21 208.5	1.10 28	2.36 60	0.12 3	M10	1.22 31	0.31 8
<b>M 4S</b>	10.16 258	7.60 193	4.65 118	4.65 118	11.67 296.5	1.50 38	3.15 80	0.12 3	M12	1.61 41	0.39 10
<b>M 4L</b>	10.16 258	7.60 193	4.65 118	4.65 118	11.67 296.5	1.50 38	3.15 80	0.12 3	M12	1.61 41	0.39 10
<b>M 4LC</b>	10.16 258	7.60 193	4.65 118	4.65 118	13.05 331.5	1.50 38	3.15 80	0.12 3	M12	1.61 41	0.39 10
<b>M 5S</b>	12.20 310	9.65 245	7.36 187	7.36 187	13.44 341.5	1.50 38	3.15 80	0.16 4	M12	1.61 41	0.39 10
<b>M 5L</b>	12.20 310	9.65 245	7.36 187	7.36 187	15.16 385	1.50 38	3.15 80	0.16 4	M12	1.61 41	0.39 10

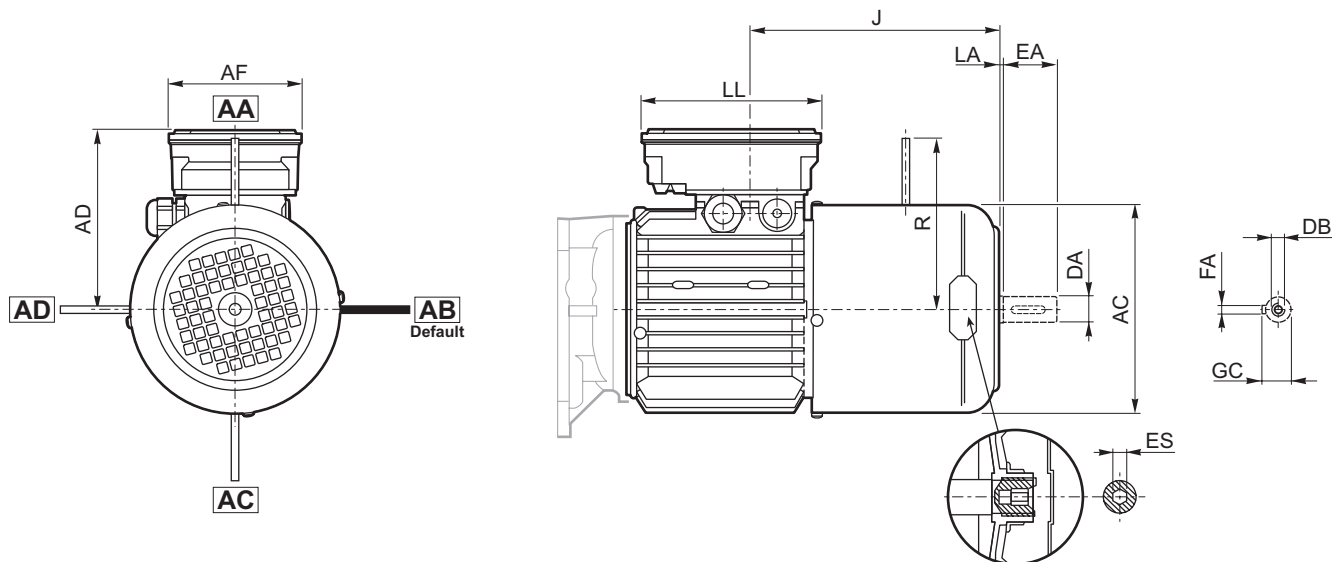

	AC	AD	AF	LL	J	R	DA	EA	LA	DB	GC	FA	ES
<b>M 05</b>	4.76 121	4.69 119	3.86 98	5.24 133	7.20 183	3.78 96	0.43 11	0.91 23	0.08 2	M4	0.49 12.5	0.16 4	0.20 5
<b>M 1S</b>	5.43 138	5.20 132	3.86 98	5.24 133	6.02 153	4.06 103	0.55 14	1.18 30	0.08 2	M5	0.63 16	0.20 5	0.20 5
<b>M 1L</b>	5.43 138	5.20 132	3.86 98	5.24 133	6.89 175	4.06 103	0.55 14	1.18 30	0.08 2	M5	0.63 16	0.20 5	0.20 5
<b>M 2S</b>	6.14 156	5.63 143	3.86 98	5.24 133	7.24 184	5.08 129	0.75 19	1.57 40	0.08 2	M6	0.85 21.5	0.24 6	0.20 5
<b>M 3S</b>	7.68 195	6.10 155	4.33 110	6.50 165	7.95 202	6.30 160	1.10 28	2.36 60	0.12 3	M10	1.22 31	0.31 8	0.24 6
<b>M 3L</b>	7.68 195	6.10 155	4.33 110	6.50 165	9.02 229	6.30 160	1.10 28	2.36 60	0.12 3	M10	1.22 31	0.31 8	0.24 6
<b>M 4S</b>	10.16 258	7.60 193	4.65 118	4.65 118	11.22 285	8.90 226	1.50 38	3.15 80	0.12 3	M12	1.61 41	0.39 10	0.24 6
<b>M 4L</b>	10.16 258	7.60 193	4.65 118	4.65 118	11.22 285	8.90 226	1.50 38	3.15 80	0.12 3	M12	1.61 41	0.39 10	0.24 6
<b>M 4LC</b>	10.16 258	7.60 193	4.65 118	4.65 118	16.97 431	8.90 226	1.50 38	3.15 80	0.12 3	M12	1.61 41	0.39 10	0.24 6
<b>M 5S</b>	12.20 310	9.65 245	7.36 187	7.36 187	18.94 481	10.47 266	1.50 38	3.15 80	0.16 4	M12	1.61 41	0.39 10	—
<b>M 5L</b>	12.20 310	9.65 245	7.36 187	7.36 187	20.67 525	10.47 266	1.50 38	3.15 80	0.16 4	M12	1.61 41	0.39 10	—

NOTE: The hexagonal socket "ES" is not available with the PS option.

Dimensions are  $\frac{\text{inch}}{\text{mm}}$

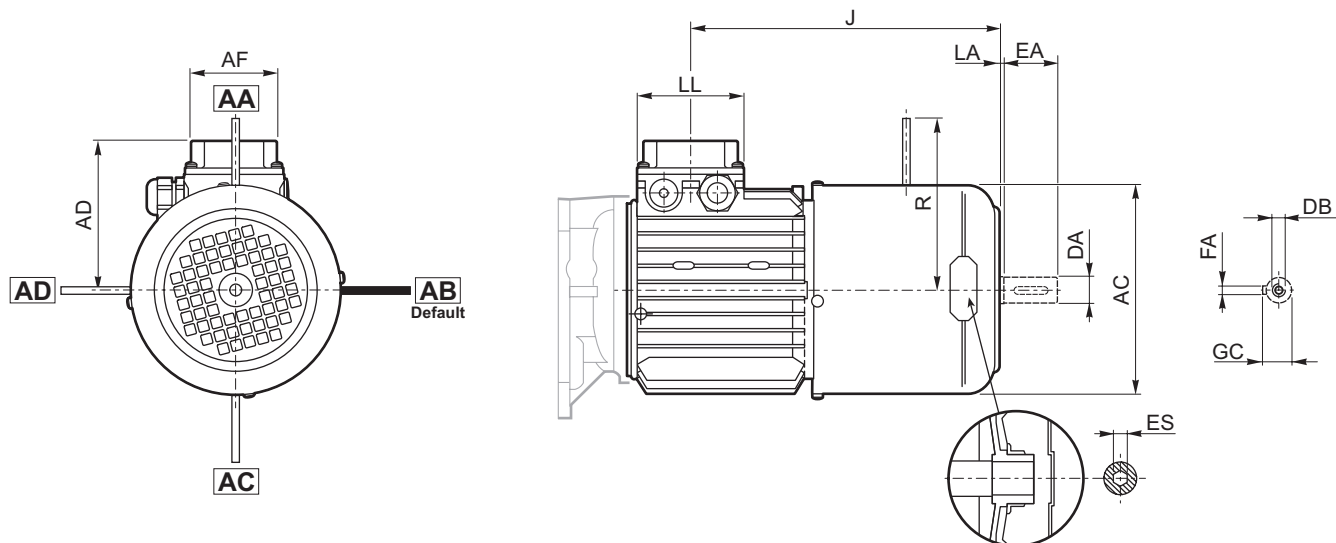

	AC	AD	AF	LL	J	R	DA	EA	LA	DB	GC	FA	ES
<b>M 05</b>	4.76	3.74	2.91	3.15	7.20	4.57	0.43	0.91	0.08	M4	0.49	0.16	0.20
	121	95	74	80	183	116	11	23	2		12.5	4	5
<b>M 1S</b>	5.43	4.25	2.91	3.15	6.02	4.88	0.55	1.18	0.08	M5	0.63	0.20	0.20
	138	108	74	80	153	124	14	30	2		16	5	5
<b>M 1L</b>	5.43	4.25	2.91	3.15	6.89	4.88	0.55	1.18	0.08	M5	0.63	0.20	0.20
	138	108	74	80	175	124	14	30	2		16	5	5
<b>M 2S</b>	6.14	4.69	2.91	3.15	7.24	5.28	0.75	1.57	0.08	M6	0.85	0.24	0.20
	156	119	74	80	184	134	19	40	2		21.5	6	5
<b>M 3S</b>	7.68	5.59	3.86	3.86	7.95	6.30	1.10	2.36	0.12	M10	1.22	0.31	0.24
	195	142	98	98	202	160	28	60	3		31	8	6
<b>M 3L</b>	7.68	5.59	3.86	3.86	9.02	6.30	1.10	2.36	0.12	M10	1.22	0.31	0.24
	195	142	98	98	229	160	28	60	3		31	8	6
<b>M 4S</b>	10.16	7.60	4.65	4.65	10.16	8.54	1.50	3.15	0.12	M14	1.61	0.39	0.24
	258	193	118	118	258	217	38	80	3		41	10	6
<b>M 4L</b>	10.16	7.60	4.65	4.65	11.22	8.54	1.50	3.15	0.12	M14	1.61	0.39	0.24
	258	193	118	118	285	217	38	80	3		41	10	6
<b>M 4LC</b>	10.16	7.60	4.65	4.65	16.97	8.54	1.50	3.15	0.12	M14	1.61	0.39	0.24
	258	193	118	118	431	217	38	80	3		41	10	6
<b>M 5S</b>	12.20	9.21	6.73	7.36	18.94	9.72	1.50	3.15	0.16	M12	1.61	0.39	—
	310	234	171	187	481	247	38	80	4		41	10	—
<b>M 5L</b>	12.20	9.21	6.73	7.36	20.67	9.72	1.50	3.15	0.16	M12	1.61	0.39	—
	310	234	171	187	525	247	38	80	4		41	10	—

NOTE: The hexagonal socket "ES" is not available with the PS option.

Dimensions are  $\frac{\text{inch}}{\text{mm}}$

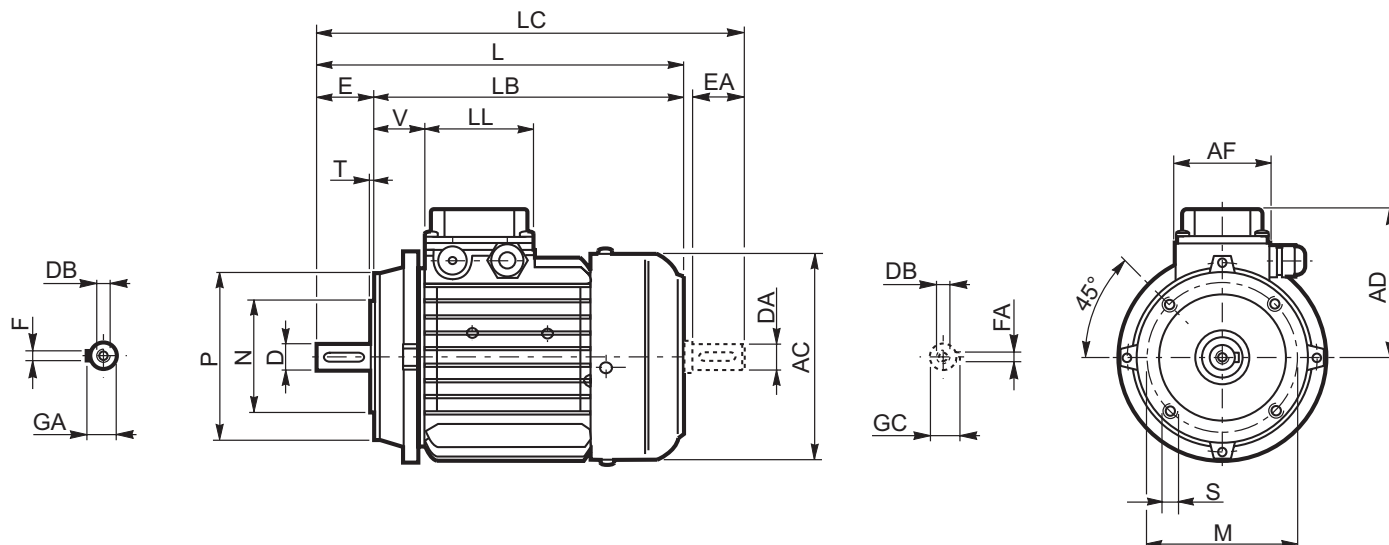

	Shaft					Flange					Motor							
	D DA	E EA	DB	GA GC	F FA	M	N	P	S	T	AC	L	LB	LC	AD	AF	LL	V
<b>BN 56</b>	0.35 9	0.79 20	M3	0.40 10.2	0.12 3	2.56 65	1.97 50	3.15 80	M5	0.10 2.5	4.33 110	7.28 185	6.50 165	8.15 207	3.58 91	2.91 74	3.15 80	1.34 34
<b>BN 63</b>	0.43 11	0.91 23	M4	0.49 12.5	0.16 4	2.95 75	2.36 60	3.54 90	M5	0.10 2.5	4.76 121	8.15 207	7.24 184	9.13 232	3.74 95	2.91 74	3.15 80	1.02 26
<b>BN 71</b>	0.55 14	1.18 30	M5	0.63 16	0.20 5	3.35 85	2.76 70	4.13 105	M6	0.10 2.5	5.43 138	9.80 249	8.62 219	11.06 281	4.25 108	2.91 74	3.15 80	1.46 37
<b>BN 80</b>	0.75 19	1.57 40	M6	0.85 21.5	0.24 6	3.94 100	3.15 80	4.72 120	M6	0.12 3	6.14 156	10.79 274	9.21 234	12.40 315	4.69 119	2.91 74	3.15 80	1.50 38
<b>BN 90 S</b>	0.94 24	1.97 50	M8	1.06 27	0.31 8	4.53 115	3.74 95	5.51 140	M8	0.12 3	6.93 176	12.83 326	10.87 276	14.88 378	5.24 133	3.86 98	3.86 98	1.73 44
<b>BN 90 L</b>	0.94 24	1.97 50	M8	1.06 27	0.31 8	4.53 115	3.74 95	5.51 140	M8	0.12 3	6.93 176	12.83 326	10.87 276	14.88 378	5.24 133	3.86 98	3.86 98	1.73 44
<b>BN 100</b>	1.10 28	2.36 60	M10	1.22 31	0.31 8	5.12 130	4.33 110	6.30 160	M8	0.14 3.5	7.68 195	14.41 366	12.05 306	16.89 429	5.59 142	3.86 98	3.86 98	1.97 50
<b>BN 112</b>	1.10 28	2.36 60	M10	1.22 31	0.31 8	5.12 130	4.33 110	6.30 160	M8	0.14 3.5	8.62 219	15.16 385	12.80 325	17.64 448	6.18 157	3.86 98	3.86 98	2.05 52
<b>BN 132 S</b>	1.50 38	3.15 80	M12	1.61 41	0.39 10	6.50 165	5.12 130	7.87 200	M10	0.16 4	10.16 258	17.91 455	14.76 375	21.18 538	7.60 193	4.65 118	4.65 118	2.28 58
<b>BN 132 M</b>	1.50 38	3.15 80	M12	1.61 41	0.39 10	6.50 165	5.12 130	7.87 200	M10	0.16 4	10.16 258	19.41 493	16.26 413	22.68 576	7.60 193	4.65 118	4.65 118	2.28 58

1) These values refer to the rear shaft end.

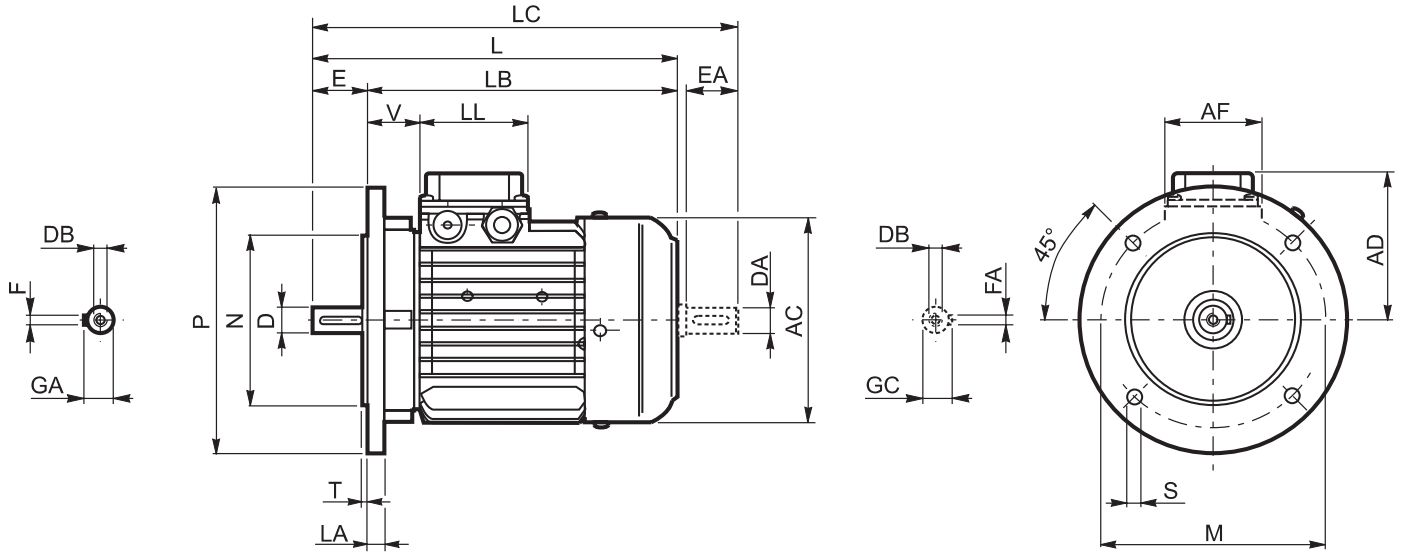

	Shaft					Flange						Motor							
	D DA	E EA	DB	GA GC	F FA	M	N	P	S	T	LA	AC	L	LB	LC	AD	AF	LL	V
BN 63	0.43	0.91	M4	0.49	0.16	4.53	3.74	5.51	0.37	0.12	0.39	4.76	8.15	7.24	9.13	3.74	2.91	3.15	1.02
	11	23		12.5	4	115	95	140	9.5	3	10	121	207	184	232	95	74	80	26
BN 71	0.55	1.18	M5	0.63	0.20	5.12	4.33	6.30	0.37	0.12	0.39	5.43	9.80	8.62	11.06	4.25	2.91	3.15	1.46
	14	30		16	5	130	110	160	9.5	3	10	138	249	219	281	108	74	80	37
BN 80	0.75	1.57	M6	0.85	0.24	6.50	5.12	7.87	0.45	0.14	0.45	6.14	10.79	9.21	12.40	4.69	2.91	3.15	1.50
	19	40		21.5	6	165	130	200	11.5	3.5	11.5	156	274	234	315	119	74	80	38
BN 90 S	0.94	1.97	M8	1.06	0.31	6.50	5.12	7.87	0.45	0.14	0.45	6.93	12.83	10.87	14.88	5.24	3.86	3.86	1.73
BN 90 L	24	50		27	8	165	130	200	11.5	3.5	11.5	176	326	276	378	133	98	98	44
BN 100	1.10	2.36	M10	1.22	0.31	8.46	7.09	9.84	0.55	0.16	0.55	7.68	14.45	12.09	16.89	5.59	3.86	3.86	1.97
	28	60		31	8	215	180	250	14	4	14	195	367	307	429	142	98	98	50
BN 112	1.10	2.36	M10	1.22	0.31	8.46	7.09	9.84	0.55	0.16	0.59	8.62	15.16	12.80	17.64	6.18	3.86	3.86	2.05
	28	60		31	8	215	180	250	14	4	15	219	385	325	448	157	98	98	52
BN 132 S	1.49	3.14	M12	1.61	0.39	10.43	9.05	11.81	0.55	0.15	0.62	10.15	17.91	14.76	21.18	7.59	4.64	4.64	2.28
	38	80		41	10	265	230	300	14	4	16	258	455	375	538	193	118	118	58
BN 132 M	1.49	3.14	M12	1.61	0.39	10.43	9.05	11.81	0.55	0.15	0.62	10.15	19.40	16.25	22.67	7.59	4.64	4.64	2.28
	38	80		41	10	265	230	300	14	4	16	258	493	413	576	193	118	118	58
BN 160 MR	1.65	4.33	M16	1.77	0.47	11.81	9.84	13.77	0.72	0.19	0.59	10.15	22.12	17.79	25.39	7.59	4.64	4.64	8.58
	42	110		45	12														
BN 160 M	1.65	4.33	M16	1.77	0.47	11.81	9.84	13.77	0.72	0.19	0.59	1.22	23.46	19.13	26.77	9.64	7.36	7.36	2.00
	42	110		45	12														
BN 180 M	1.88	4.33	M16	2.02	0.55	11.81	9.84	13.77	0.72	0.19	0.59	1.22	25.19	20.86	28.50	9.64	7.36	7.36	2.00
	48	110		51.5	14														
BN 180 L	1.88	4.33	M16	2.02	0.55	11.81	9.84	13.77	0.72	0.19	0.70	13.70	27.87	23.54	32.40	10.27	7.36	7.36	2.04
	48	110		51.5	14														
BN 200 L	2.16	4.33	M20	2.32	0.62	13.77	11.81	15.74	0.72	0.19	0.70	13.70	28.42	24.09	32.95	10.27	7.36	7.36	2.59
	55	110		59	16														

1) These values refer to the rear shaft end.

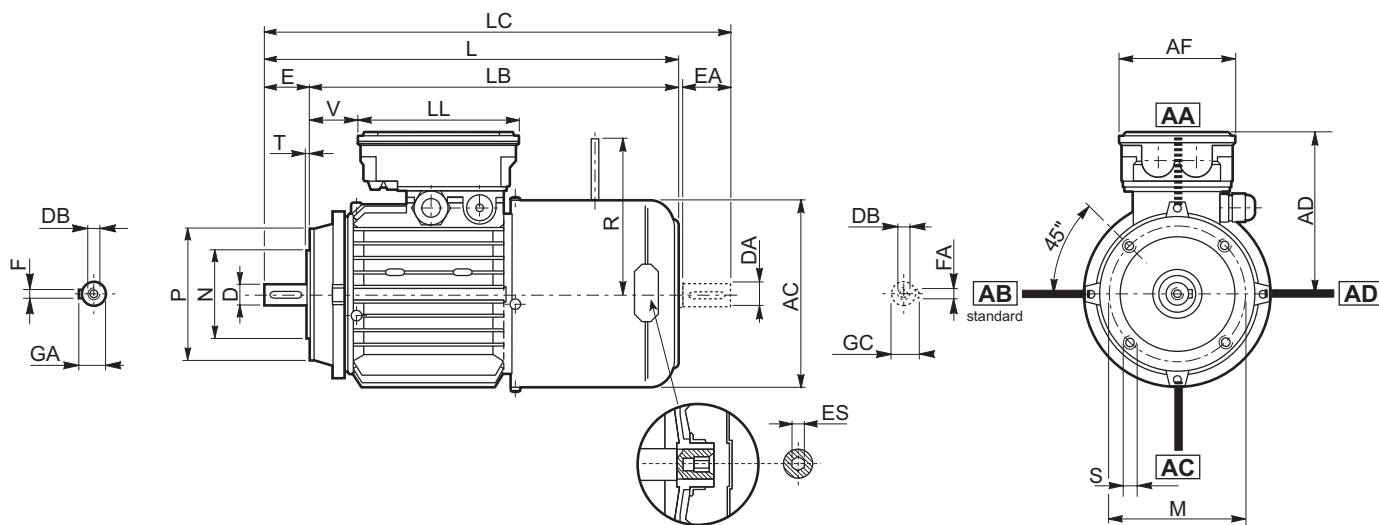

	Shaft					Flange					Motor									
	D DA	E EA	DB	GA GC	F FA	M	N	P	S	T	AC	L	LB	LC	AD	AF	LL	V	R	ES
<b>BN 63</b>	0.43 11	0.91 23	M4	0.49 12.5	0.16 4	2.95 75	2.36 60	3.54 90	M5	0.10 2.5	4.76 121	10.71 272	9.80 249	11.69 297	4.69 119	3.86 98	5.24 133	0.55 14	3.78 96	0.20 5
<b>BN 71</b>	0.55 14	1.18 30	M5	0.63 16	0.20 5	3.35 85	2.76 70	4.13 105	M6	0.10 2.5	5.43 138	12.20 310	11.02 280	13.46 342	5.20 132	3.86 98	5.24 133	1.18 30	4.06 103	0.20 5
<b>BN 80</b>	0.75 19	1.57 40	M6	0.85 21.5	0.24 6	3.94 100	3.15 80	4.72 120	M6	0.12 3	6.14 156	13.62 346	12.05 306	15.28 388	5.63 143	3.86 98	5.24 133	1.61 41	5.08 129	0.20 5
<b>BN 90 S</b>	0.94 24	1.97 50	M8	1.06 27	0.31 8	4.53 115	3.74 95	5.51 140	M8	0.12 3	6.93 176	16.10 409	14.13 359	18.15 461	5.75 146	4.33 110	6.50 165	1.54 39	5.08 129	0.24 6
<b>BN 90 L</b>	0.94 24	1.97 50	M8	1.06 27	0.31 8	4.53 115	3.74 95	5.51 140	M8	0.12 3	6.93 176	16.10 409	14.13 359	18.15 461	5.75 146	4.33 110	6.50 165	1.54 39	6.30 160	0.24 6
<b>BN 100</b>	1.10 28	2.36 60	M10	1.22 31	0.31 8	5.12 130	4.33 110	6.30 160	M8	0.14 3.5	7.68 195	18.03 458	15.67 398	20.51 521	6.10 155	4.33 110	6.50 165	2.44 62	6.30 160	0.24 6
<b>BN 112</b>	1.10 28	2.36 60	M10	1.22 31	0.31 8	5.12 130	4.33 110	6.30 160	M8	0.14 3.5	8.62 219	19.06 484	16.69 424	21.54 547	6.69 170	4.33 110	6.50 165	2.87 73	7.83 199	0.24 6
<b>BN 132 S</b>	1.50 38	3.15 80	M12	1.61 41	0.39 10	6.50 165	5.12 130	7.87 200	M10	0.16 4	10.16 258	22.24 565	19.09 485	25.51 648	7.60 193	4.65 118	4.65 118	5.59 142	8.03 204 (2)	0.24 6
<b>BN 132 M</b>	1.50 38	3.15 80	M12	1.61 41	0.39 10	6.50 165	5.12 130	7.87 200	M10	0.16 4	10.16 258	23.74 603	20.59 523	27.01 686	7.60 193	4.65 118	4.65 118	7.09 180	8.03 204 (2)	0.24 6

1) These values refer to the rear shaft end.  
2) For FD07 brake value R=226

ES hexagon is not supplied with PS option

Dimensions are  $\frac{\text{inch}}{\text{mm}}$



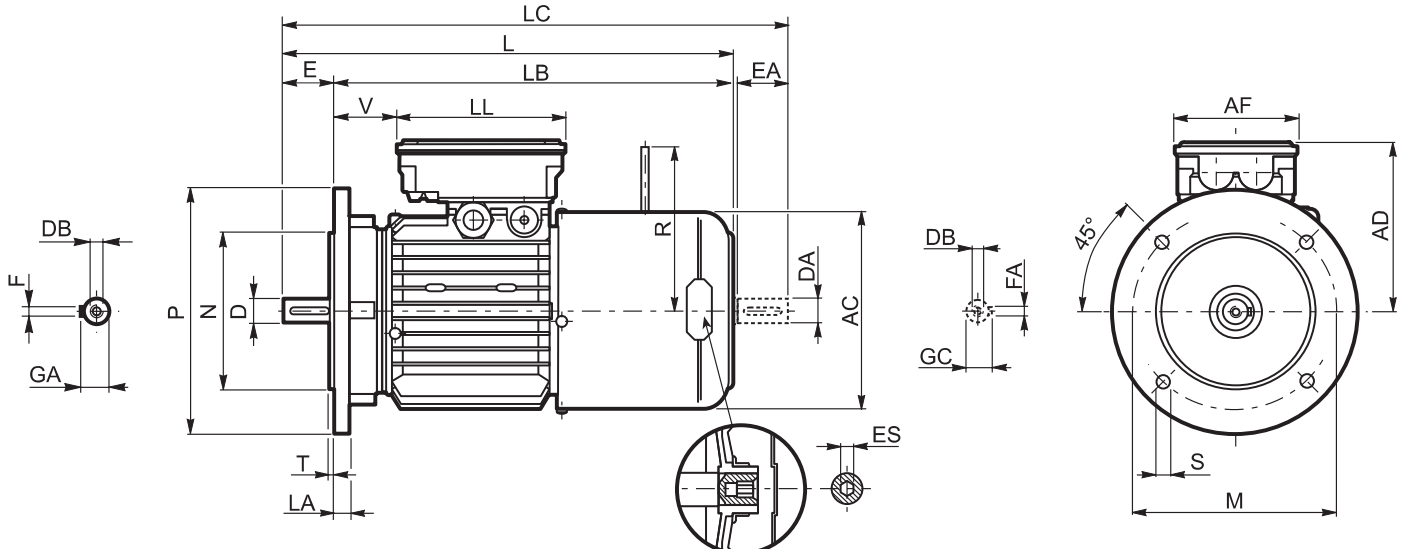

	Shaft					Flange						Motor									
	D DA	E EA	DB	GA GC	F FA	M	N	P	S	T	LA	AC	L	LB	LC	AD	AF	LL	V	R	ES
<b>BN 63</b>	0.43 11	0.91 23	M4	0.49 12.5	0.16 4	4.53 115	3.74 95	5.51 140	0.37 9.5	0.12 3	0.39 10	4.76 121	10.71 272	9.80 249	11.69 297	4.69 119	3.86 98	5.24 133	0.55 14	3.78 96	0.20 5
<b>BN 71</b>	0.55 14	1.18 30	M5	0.63 16	0.20 5	5.12 130	4.33 110	6.30 160	0.37 9.5	0.14 3.5	0.39 10	5.43 138	12.20 310	11.02 280	13.46 342	5.20 132	3.86 98	5.24 133	1.18 30	4.06 103	0.20 5
<b>BN 80</b>	0.75 19	1.57 40	M6	0.85 21.5	0.24 6	6.50 165	5.12 130	7.87 200	0.45 11.5	0.14 3.5	0.45 11.5	6.14 156	13.62 346	12.05 306	15.28 388	5.63 143	3.86 98	5.24 133	1.61 41	5.08 129	0.20 5
<b>BN 90 S</b>	0.94 24	1.97 50	M8	1.06 27	0.31 8	6.50 165	5.12 130	7.87 200	0.45 11.5	0.14 3.5	0.45 11.5	6.93 176	16.10 409	14.13 359	18.15 461	5.75 146	4.33 110	6.50 165	1.54 39	5.08 129	0.24 6
<b>BN 90 L</b>	0.94 24	1.97 50	M8	1.06 27	0.31 8	6.50 165	5.12 130	7.87 200	0.45 11.5	0.14 3.5	0.45 11.5	6.93 176	16.10 409	14.13 359	18.15 461	5.75 146	4.33 110	6.50 165	1.54 39	6.30 160	0.24 6
<b>BN 100</b>	1.10 28	2.36 60	M10	1.22 31	0.31 8	8.46 215	7.09 180	9.84 250	0.55 14	0.16 4	0.55 14	7.68 195	18.03 458	15.67 398	20.51 521	6.10 155	4.33 110	6.50 165	2.44 62	6.30 160	0.24 6
<b>BN 112</b>	1.10 28	2.36 60	M10	1.22 31	0.31 8	8.46 215	7.09 180	9.84 250	0.55 14	0.16 4	0.59 15	8.62 219	19.06 484	16.69 424	21.54 547	6.69 170	4.33 110	6.50 165	2.87 73	7.83 199	0.24 6
<b>BN 132 S</b>	1.49 38	3.14 80	M12	1.61 41	0.39 10	10.43 265	9.05 230	11.81 300	0.55 14	0.15 4	0.62 16	10.15 258	22.24 565	19.09 485	25.51 648	7.59 193	4.64 118	4.64 118	5.59 142	8.03 204 (2)	0.23 6
<b>BN 132 M</b>	1.49 38	3.14 80	M12	1.61 41	0.39 10	10.43 265	9.05 230	11.81 300	0.55 14	0.15 4	0.62 16	10.15 258	23.74 603	20.59 523	27.00 686	7.59 193	4.64 118	4.64 118	7.08 180	8.03 204 (1)	0.23 6
<b>BN 160 MR</b>	1.65 42	4.33 110	M16	1.77 45	0.47 12	11.81	9.84	13.77	0.72	0.19	0.59	10.15	26.45	22.12	29.72	7.59	4.64	4.64	8.58	8.89	0.23
	1.49 38 (1)	3.14 80 (1)	M12 (1)	1.61 41 (1)	0.39 10 (1)																
<b>BN 160 M BN 160 L</b>	1.65 42	4.33 110	M16	1.77 45	0.47 12	11.81	9.84	13.77	0.72	0.19	0.59	1.22	28.97	24.64	32.28	9.64	7.36	7.36	2.00	8.89	
	1.49 38 (1)	3.14 80 (1)	M12 (1)	1.61 41 (1)	0.39 10 (1)																
<b>BN 180 M</b>	1.88 48	4.33 110	M16	2.02 51.5	0.55 14	11.81	9.84	13.77	0.72	0.19	0.59	1.22	30.70	26.37	34.01	9.64	7.36	7.36	2.00	8.89	
	1.49 38 (1)	4.33 110 (1)	M12 (1)	1.61 41 (1)	0.39 10 (1)																
<b>BN 180 L</b>	1.88 48	4.33 110	M16	2.02 51.5	0.55 14	11.81	9.84	13.77	0.72	0.19	0.70	13.70	34.09	29.76	38.62	10.27	7.36	7.36	2.04	12.00	
	1.65 42 (1)	4.33 110 (1)	M16 (1)	1.77 45 (1)	0.47 12 (1)																
<b>BN 200 L</b>	2.16 55	4.33 110	M20	2.32 59	0.62 16	13.77	11.81	15.74	0.72	0.19	0.70	13.70	34.56	30.23	39.09	10.27	7.36	7.36	2.51	12.00	
	1.65 42 (1)	4.33 110 (1)	M16 (1)	1.77 45 (1)	0.47 12 (1)																

1) These values refer to the rear shaft end.  
2) For FD07 brake value R=226

ES hexagon is not supplied with PS option

Dimensions are  $\frac{\text{inch}}{\text{mm}}$

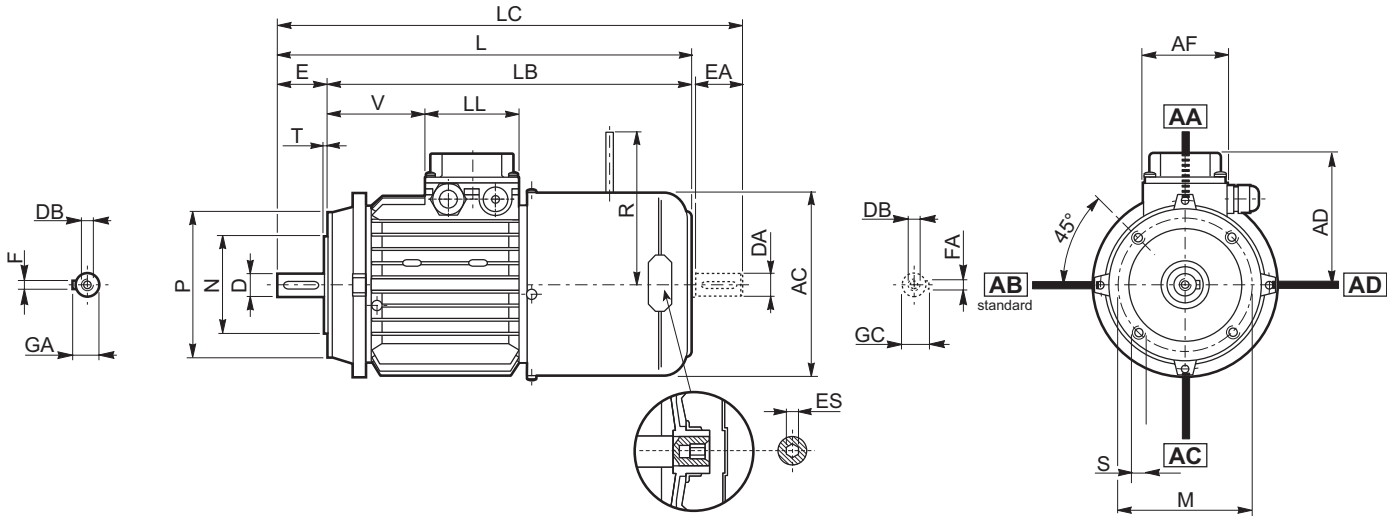

	Shaft					Flange					Motor									
	D DA	E EA	DB	GA GC	F FA	M	N	P	S	T	AC	L	LB	LC	AD	AF	LL	V	R	ES
<b>BN 63</b>	0.43 11	0.91 23	M4	0.49 12.5	0.16 4	2.95 75	2.36 60	3.54 90	M5	0.10 2.5	4.76 121	10.71 272	9.80 249	4.69 119	3.74 95	2.91 74	3.15 80	1.02 26	4.57 116	0.20 5
<b>BN 71</b>	0.55 14	1.18 30	M5	0.63 16	0.20 5	3.35 85	2.76 70	4.13 105	M6	0.10 2.5	5.43 138	12.20 310	11.02 280	13.46 342	4.25 108	2.91 74	3.15 80	2.68 68	4.88 124	0.20 5
<b>BN 80</b>	0.75 19	1.57 40	M6	0.85 21.5	0.24 6	3.94 100	3.15 80	4.72 120	M6	0.12 3	6.14 156	13.62 346	12.05 306	15.28 388	4.69 119	2.91 74	3.15 80	3.27 83	5.28 134	0.20 5
<b>BN 90 S</b>	0.94 24	1.97 50	M8	1.06 27	0.31 8	4.53 115	3.74 95	5.51 140	M8	0.12 3	6.93 176	16.10 409	14.13 359	18.15 461	5.24 133	3.86 98	3.86 98	3.74 95	5.28 134	0.24 6
<b>BN 90 L</b>	0.94 24	1.97 50	M8	1.06 27	0.31 8	4.53 115	3.74 95	5.51 140	M8	0.12 3	6.93 176	16.10 409	14.13 359	18.15 461	5.24 133	3.86 98	3.86 98	3.74 95	6.30 160	0.24 6
<b>BN 100</b>	1.10 28	2.36 60	M10	1.22 31	0.31 8	5.12 130	4.33 110	6.30 160	M8	0.14 3.5	7.68 195	18.03 458	15.67 398	20.51 521	5.59 142	3.86 98	3.86 98	4.69 119	6.30 160	0.24 6
<b>BN 112</b>	1.10 28	2.36 60	M10	1.22 31	0.31 8	5.12 130	4.33 110	6.30 160	M8	0.14 3.5	8.62 219	19.06 484	16.69 424	21.54 547	6.18 157	3.86 98	3.86 98	5.04 128	7.80 198	0.24 6
<b>BN 132 S</b>	1.50 38	3.15 80	M12	1.61 41	0.39 10	6.50 165	5.12 130	7.87 200	M10	0.16 4	10.16 258	22.24 565	19.09 485	25.51 648	7.60 193	4.65 118	4.65 118	5.59 142	7.87 200 (2)	0.24 6
<b>BN 132 M</b>	1.50 38	3.15 80	M12	1.61 41	0.39 10	6.50 165	5.12 130	7.87 200	M10	0.16 4	10.16 258	23.74 603	20.59 523	27.01 686	7.60 193	4.65 118	4.65 118	7.09 180	7.87 200 (2)	0.24 6

1) These values refer to the rear shaft end.

2) For FD07 brake value R=226

ES hexagon is not supplied with PS option.

For motors type BN..FA, the terminal box sizes AD, AF, LL, V are the same as for BN..FD.

Dimensions are  $\frac{\text{inch}}{\text{mm}}$

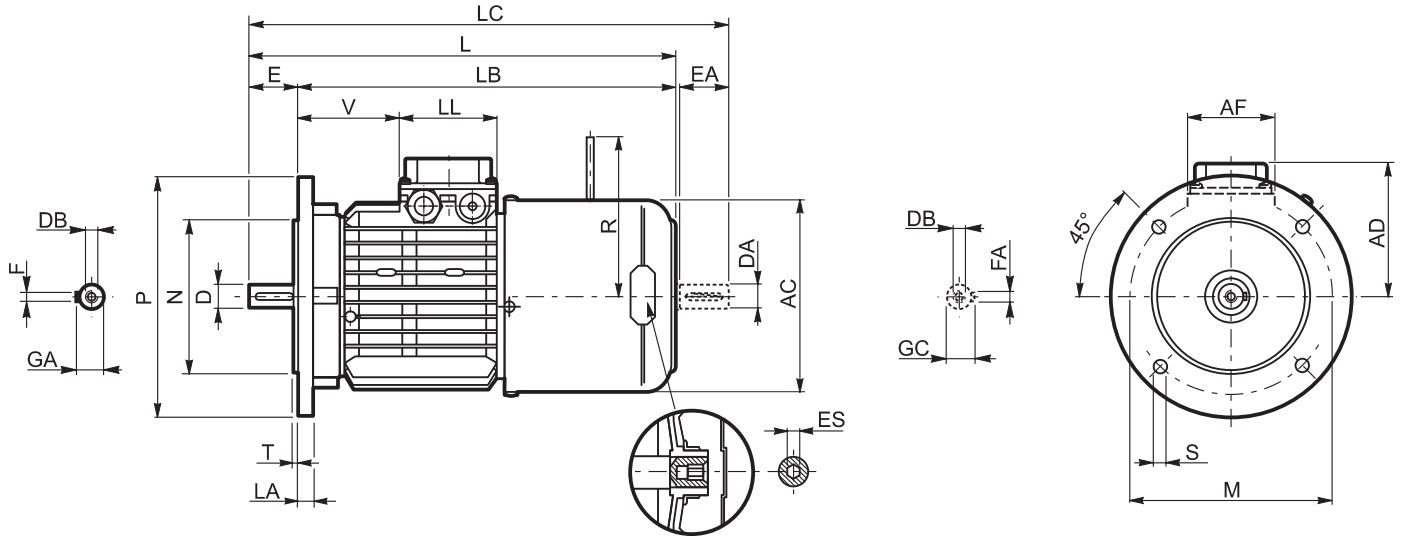

	Shaft					Flange						Motor									
	D DA	E EA	DB	GA GC	F FA	M	N	P	S	T	LA	AC	L	LB	LC	AD	AF	LL	V	R	ES
<b>BN 63</b>	0.43 11	0.91 23	M4	0.49 12.5	0.16 4	4.53 115	3.74 95	5.51 140	0.37 9.5	0.12 3	0.39 10	4.76 121	10.71 272	9.80 249	11.69 297	3.74 95	2.91 74	3.15 80	1.02 26	4.57 116	0.20 5
<b>BN 71</b>	0.55 14	1.18 30	M5	0.63 16	0.20 5	5.12 130	4.33 110	6.30 160	0.37 9.5	0.14 3.5	0.39 10	5.43 138	12.20 310	11.02 280	13.46 342	4.25 108	2.91 74	3.15 80	2.68 68	4.88 124	0.20 5
<b>BN 80</b>	0.75 19	1.57 40	M6	0.85 21.5	0.24 6	6.50 165	5.12 130	7.87 200	0.45 11.5	0.14 3.5	0.45 11.5	6.14 156	13.62 346	12.05 306	15.28 388	4.69 119	2.91 74	3.15 80	3.27 83	5.28 134	0.20 5
<b>BN 90 S</b>	0.94 24	1.97 50	M8	1.06 27	0.31 8	6.50 165	5.12 130	7.87 200	0.45 11.5	0.14 3.5	0.45 11.5	6.93 176	16.10 409	14.13 359	18.15 461	5.24 133	3.86 98	3.86 98	3.74 95	5.28 134	0.24 6
<b>BN 90 L</b>	0.94 24	1.97 50	M8	1.06 27	0.31 8	6.50 165	5.12 130	7.87 200	0.45 11.5	0.14 3.5	0.45 11.5	6.93 176	16.10 409	14.13 359	18.15 461	5.24 133	3.86 98	3.86 98	3.74 95	6.30 160	0.24 6
<b>BN 100</b>	1.10 28	2.36 60	M10	1.22 31	0.31 8	8.46 215	7.09 180	9.84 250	0.55 14	0.16 4	0.55 14	7.68 195	18.03 458	15.67 398	20.51 521	5.59 142	3.86 98	3.86 98	4.69 119	6.30 160	0.24 6
<b>BN 112</b>	1.10 28	2.36 60	M10	1.22 31	0.31 8	8.46 215	7.09 180	9.84 250	0.55 14	0.16 4	0.59 15	8.62 219	19.06 484	16.69 424	21.54 547	6.18 157	3.86 98	3.86 98	5.04 128	7.80 198	0.24 6
<b>BN 132 S</b>	1.49 38	3.14 80	M12	1.61 41	0.39 10	10.43 265	9.05 230	11.81 300	0.55 14	0.15 4	0.62 16	10.15 258	22.24 565	19.09 485	25.51 648	7.59 193	4.64 118	4.64 118	5.59 142	7.87 200(2)	0.23 6
<b>BN 132 M</b>	1.49 38	3.14 80	M12	1.61 41	0.39 10	10.43 265	9.05 230	11.81 300	0.55 14	0.15 4	0.62 16	10.15 258	23.74 603	20.59 523	27.00 686	7.59 193	4.64 118	4.64 118	7.08 180	7.87 200(1)	0.23 6
<b>BN 160 MR</b>	1.65 42	4.33 110	M16	1.77 45	0.47 12	11.81 300	9.84 250	13.77 350	0.72 18.5	0.19 5	0.59 15	10.15 258	26.45 672	22.12 562	29.72 755	7.59 193	4.64 118	4.64 118	8.58 218	8.54 217	0.23 6
	1.49 38(1)	3.14 80(1)	M12(1)	1.61 41(1)	0.39 10(1)																
<b>BN 160 M</b> <b>BN 160 L</b>	1.65 42	4.33 110	M16	1.77 45	0.47 12	11.81 300	9.84 250	13.77 350	0.72 18.5	0.19 5	0.59 15	1.22 310	28.97 736	24.64 626	32.28 820	9.64 245	7.36 187	7.36 187	2.00 51	9.72 247	
	1.49 38(1)	3.14 80(1)	M12(1)	1.61 41(1)	0.39 10(1)																
<b>BN 180 M</b>	1.88 48	4.33 110	M16	2.02 51.5	0.55 14	11.81 300	9.84 250	13.77 350	0.72 18.5	0.19 5	0.59 15	1.22 310	30.70 780	26.37 670	34.01 864	9.64 245	7.36 187	7.36 187	2.00 51	9.72 247	
	1.49 38(1)	3.14 80(1)	M12(1)	1.61 41(1)	0.39 10(1)																

1) These values refer to the rear shaft end.

2) For FD07 brake value R=226

ES hexagon is not supplied with PS option.

For motors type BN..FA, the terminal box sizes AD, AF, LL, V are the same as for BN..FD.

**R2**

Updated pages relative to electric motors.

## Torque

$$M_2 = M_1 \times i \times \eta$$

$$T_2 \text{ (lb}\cdot\text{in)} = \frac{\text{Hp} \times 63025 \times \eta}{n \text{ (rpm)}}$$

$$T_2 \text{ (lb}\cdot\text{ft)} = \frac{\text{Hp} \times 5252 \times \eta}{n \text{ (rpm)}}$$

$$M_2 \text{ (Nm)} = \frac{\text{Kw} \times 9550 \times \eta}{n \text{ (rpm)}}$$

$$M_2 \text{ (Nm)} = \frac{\text{Hp} \times 7121 \times \eta}{n \text{ (rpm)}}$$

## Power

$$P_1 \text{ (Hp)} = \frac{\text{Torque (lb}\cdot\text{in)} \times n_2 \text{ (rpm)}}{63025 \times \eta}$$

$$P_1 \text{ (Hp)} = \frac{\text{Torque (lb}\cdot\text{ft)} \times n_2 \text{ (rpm)}}{5252 \times \eta}$$

$$P_1 \text{ (Hp)} = \frac{\text{Torque (Nm)} \times n_2 \text{ (rpm)}}{7121 \times \eta}$$

$$P_1 \text{ (Kw)} = \frac{\text{Torque (Nm)} \times n_2 \text{ (rpm)}}{9550 \times \eta}$$

## Products

**W, VF** – worm gear

**VFR** – helical / worm

**C, S** – in-line helical

**A, RAO** – right angle bevel helical

**RAP** – parallel shaft

**RAN** – single stage right angle

**F, TA** – shaft mount helical

**V** – mechanical variator

**300 Series** – planetary drives

**BN** – Bonfiglioli IEC motor

Note: Speed Reducers available as a gearbox or gearmotor.

